

TIA

09035

6RPTW

Manufacturing Use Only

AFE Manufacturing Form  
6 Row Pull Type Windrower

Serial Number: 09035  
Customer: T A FARMS LTD  
Dealer: HJV EQUIP

12-11-08 L.A.

Standard Equipment:		Special Notes	
1000 RPM PTO	X		
Rear Steering	X		
Dual 24" Coulters	X		
2-17.5 x 24 Tires			
28L X 26 TIRES KINZE SPINDLES	X		
Heavy Duty 10 Bolt Bud Wheels			
Rotating Hydraulic Vibrator in Primary			
35" Cross			
40" Cross	X		
Center Pull Hitch	X		
Fully Hydraulic	X		
Electric Hydraulic Valves	X		
Standard Belted Chain	X		
	<i>Options</i>		
<i>Row Spacing</i>			
* 32" with 30" chain			
* 34" with 32" chain			
* 36" with 33" chain		6PW0803	TO BE DETERMINED
* 36" with 34" chain	X		BUILD CLOD BLADE TO CENTE
* 38" with 36" chain			ON 38 INCH ROWS
<i>Rear Tires</i>			
* 16.5 X 16.1 Tires			
* 17.5 X 24 Tires			
* 28L X 26 Tires w/ Kinze Spindles	X	6PW0303	
<i>Hitch Option</i>			
* Center Pull Hitch	X	6PW6100	
<i>Digger Blade Bracket</i>			
* Standard		6PW0900	
* Rock Guard	X		
<i>Digger Blades</i>			
* Regular Straight			
* Extended Straight			
* Clod Blades	X	6PW1004	UHMW UNDER BLADE
* Sand Blades			BUILT PER PICTURES
* Full Width Solid Blade 1/4" x 12"			SENT TO GREG W/ SPECIAL
<i>Primary Bed</i>			NOSE PIECES WITH 1 ROUND
* Full Width Common Lift			ROD LIKE LOCKWOOD
* Full Width Side to Side Control	X	6PW1301	
* 2-3 Row Bed's			

Manufacturing Use Only

AFE Manufacturing Form  
6 Row Pull Type Windrower

Serial Number: \_\_\_\_\_  
 Customer: T A FARMS LTD  
 Dealer: HJV EQUIP

<b>Primary Drive</b>			
*Top Drive	X	6PW1201	
* Reverse Drive			
<b>Primary Bed Chains</b>			
* Single Width Belted	X	6PW1400	
* Double Width Belted			
* Double Width w/ Double Belt Center			
<b>Primary Belted Chains</b>			
* 45 mm All Straight Belted Chains			
* 45 mm 2 Down & 1 Straight Belted Chains			
* 50 mm All Straight Belted Chains			
* 50 mm 2 Down & 1 Straight Belted Chains			
* 50 mm 1 Up & 2 Down Belted Chains			
* 56 mm All Straight Belted Chains	X	6PW1505	ALL DOWN RODS
<b>Primary Gear Box Option</b>			
* 2,000 Hydraulic Motor			
* 6,000 Hydraulic Motor			
* 6,000 Hydraulic Motor w/Gearbox	X	6PW2202	
* VIS Direct Drive Motor			
<b>Reversing Valve Primary</b>			
* No Reversing Valves	X	6PW2601	
* Primary			
<b>Vibrator Primary</b>			
*No Vibrator			
* 2 <sup>nd</sup> Rotating Hydraulic Shaker Primary	X	6PW2704	
*Rocking Hydraulic Shaker Primary			
<b>Secondary Bed Chains</b>			
* Single Belted SRT	X	6PW1602	
* Full Belted 65" SRT			
<b>Secondary Belted Chains</b>			
* 45 mm All Straight SRT			
* 45 mm 2 Down & 1 Straight SRT			
* 50 mm All Straight SRT			
* 50 mm 2 Down & 1 Straight SRT	x	6PW1703	56mm all S
<b>Secondary Gear Box Option</b>			
* 2,000 Hydraulic Motor			
* 6,000 Hydraulic Motor			
* 6,000 Hydraulic Motor w/Gear Box	X	6PW2302	

Manufacturing Use Only

AFE Manufacturing Form  
6 Row Pull Type Windrower

Serial Number: \_\_\_\_\_  
 Customer: T A FARMS LTD  
 Dealer: HJV EQUIP

<b>Deviner Gear Box Option</b>		
* 2,000 Hydraulic Motor		
* 6,000 Hydraulic Motor		
* 6,000 Hydraulic Motor with Gear Box	X	6PW2502
<b>Deviner Belted Chain</b>		
* 150mm Belted Chain		
* 180mm Belted Chain	X	6PW2801
* 200mm Belted Chain		
<b>Cross Conveyor</b>		
* Right Hand Discharge		
* Left Hand Discharge	X	6PW6302
* Reversible Rear Cross		
* Split 24" Cross		
<b>Rear Cross</b>		
* 35" Cross		
* 40" Cross	X	6PW3401
* 48" Cross		
<b>Rear Cross Chain</b>		
* 40 mm All Straight SRT		
* 45 mm All Straight SRT	X	6PW3501
<b>Secondary Star Table Options</b>		
* No Star Table Option		
* 5 Stars with Distributor Stars on the Cross		
* 6 Stars with 2 Adjustable Smooth Rollers and Distributor Stars on Cross	X	6PW2102
* 6 Stars with 2 Adjustable Smooth Roll and Distributor Stars on Cross, extra Star Roller on left		
<b>Rear Leveling</b>		
* No Rear Leveling	X	6PW6200
* Rear Leveling		
<b>Gauge Wheels</b>		
* No Gauge Wheels		
* Two Single Gauge Wheels	X	6PW5501
<b>Vine Separators</b>		
* Double Disk Coulters	X	6PW2900
* Kickers		

AFE Manufacturing Form  
 6 Row Pull Type Windrower

Manufacturing Use Only

Serial Number: \_\_\_\_\_  
 Customer: T A FARMS LTD  
 Dealer: HJV EQUIP

3 <sup>rd</sup> Coultter Assembly			
* No 3 <sup>rd</sup> Coultter			
* One Coultter			
* Two Coultter			

Customer Acceptance: Ben M.  
 Dealer Acceptance: Thaddeus Jewell  
 AFE Acceptance: [Signature] 12-11-08

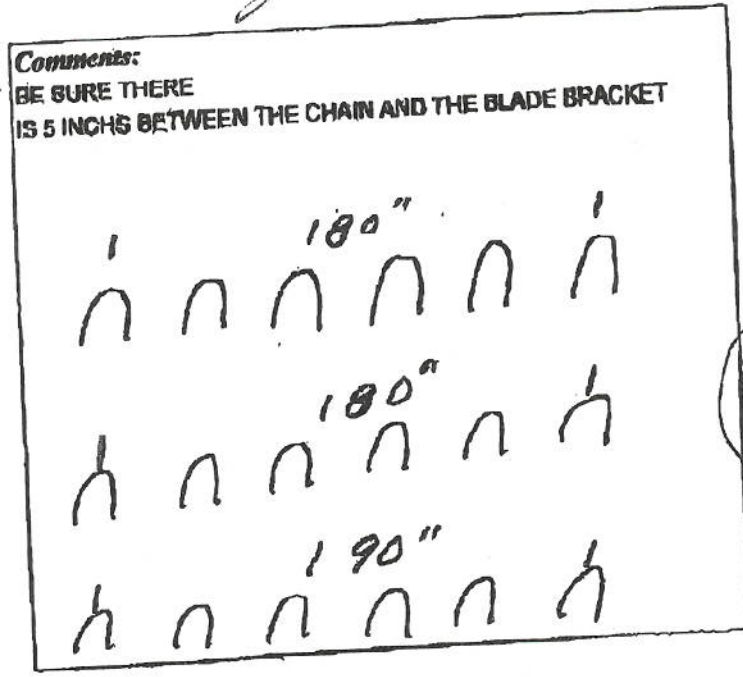

33" Digger Bed Chain  
 36" Rows 212" width

34" Digger Bed Chain  
 38" Rows 215" width

36" Digger Bed Chain  
 38" Rows 226"

Question if you dig 38" Rows  
 is 11" ENOUGH ON EACH SIDE OF THE  
 CENTER OF THE HILL

CENTER DOG OF EACH BLADE  
 SO THE ARE ON 38" ROWS

← 228"

Manufacturing Use Only

AFE Manufacturing Form  
6 Row Pull Type Windrower

Serial Number: \_\_\_\_\_  
Customer: T A FARMS LTD  
Dealer: HJV EQUIP

Mfg	Chain/Location	Qty	Rod Size	Width	MM	LPR
	Primary	7	0.5	34	56	
	Secondary	3	0.44	69	56	
	Deviner	3	0.65	<del>68</del> <sup>69</sup>	180	
	Cross	3	0.44	40	45	

Manufacturing Use Only

AFE Manufacturing Form  
6 Row Pull Type Windrower

Serial Number: 09035  
Customer: T A FARMS LTD  
Dealer: HJV EQUIP

HJV P.O  
# 165576

Page 1 of 5

4-27-09

<i>Standard Equipment:</i>		<i>Special Notes</i>	
1000 RPM PTO	X		
Rear Steering	X		
Dual 24" Coulters	X		
2-17.5 x 24 Tires			
28L X 26 TIRES KINZE SPINDLES	X		
Heavy Duty 10 Bolt Bud Wheels			
Rotating Hydraulic Vibrator in Primary			
35" Cross			
40" Cross	X		
Center Pull Hitch	X		
Fully Hydraulic	X		
Electric Hydraulic Valves	X		
Standard Belted Chain	X		
	<i>Options</i>		
<i>Row Spacing</i>			
* 32" with 30" chain			
* 34" with 32" chain			
* 36" with 33" chain		6PW0803	TO BE DETERMINED
* 36" with 34" chain	X		BUILD CLOD BLADE TO CENTE
* 38" with 36" chain			ON 38 INCH ROWS
<i>Rear Tires</i>			
* 16.5 X 16.1 Tires			
* 17.5 X 24 Tires			
* 28L X 26 Tires w/ Kinza Spindles	X	6PW0303	
<i>Hitch Option</i>			
* Center Pull Hitch	X	6PW6100	
<i>Digger Blade Bracket</i>			
* Standard		6PW0900	
* Rock Guard	X		
<i>Digger Blades</i>			
* Regular Straight			
* Extended Straight			
* Clod Blades	X	6PW1004	UHMW UNDER BLADE
* Sand Blades			BUILT PER PICTURES
* Full Width Solid Blade ¾" x 12"			SENT TO GREG W/ SPECIAL
<i>Primary Bed</i>			NOSE PIECES WITH 1 ROUND
* Full Width Common Lift			ROD LIKE LOCKWOOD
* Full Width Side to Side Control	X	6PW1301	
* 2-3 Row Bed's			

Manufacturing Use Only

AFE Manufacturing Form  
6 Row Pull Type Windrower

Serial Number: \_\_\_\_\_  
Customer: T A FARMS LTD  
Dealer: HJV EQUIP

*HJV P.O. # 165576*

*Page 2 of 5*

<b>Primary Drive</b>			
*Top Drive			
* Reverse Drive	X	6PW1201	
<b>Primary Bed Chains</b>			
* Single Width Belted	X	6PW1400	
* Double Width Belted			
* Double Width w/ Double Belt Center			
<b>Primary Belted Chains</b>			
* 45 mm All Straight Belted Chains			
* 45 mm 2 Down & 1 Straight Belted Chains			
* 50 mm All Straight Belted Chains			
* 50 mm 2 Down & 1 Straight Belted Chains			
* 50 mm 1 Up & 2 Down Belted Chains			
* 56 mm All Straight Belted Chains	X	6PW1505	ALL DOWN RODS
<b>Primary Gear Box Option</b>			
* 2,000 Hydraulic Motor			
* 6,000 Hydraulic Motor			
* 6,000 Hydraulic Motor w/Gearbox	X	6PW2202	
* VIS Direct Drive Motor			
<b>Reversing Valve Primary</b>			
* No Reversing Valves			
* Primary	X	6PW2601	
<b>Vibrator Primary</b>			
*No Vibrator			
*2 <sup>nd</sup> Rotating Hydraulic Shaker Primary			
*Rocking Hydraulic Shaker Primary	X	6PW2704	
<b>Secondary Bed Chains</b>			
* Single Belted SRT			
* Full Belted 65" SRT	X	6PW1602	
<b>Secondary Belted Chains</b>			
* 45 mm All Straight SRT			
* 45 mm 2 Down & 1 Straight SRT			
* 50 mm All Straight SRT			
* <del>50 mm 2 Down &amp; 1 Straight SRT</del>	X	6PW1703	<i>56mm ALL ST</i>
<b>Secondary Gear Box Option</b>			
* 2,000 Hydraulic Motor			
* 6,000 Hydraulic Motor			
* 6,000 Hydraulic Motor w/Gear Box	X	6PW2302	



Serial Number: \_\_\_\_\_  
 Customer: T A FARMS LTD  
 Dealer: HJV EQUIP

HJV. P.O. #  
165576.

Page #3 of 5.

<b>Deviner Gear Box Option</b>			
* 2,000 Hydraulic Motor			
* 6,000 Hydraulic Motor			
* 6,000 Hydraulic Motor with Gear Box	X	6PW2502	
<b>Deviner Belted Chain</b>			
* 150mm Belted Chain			
* 180mm Belted Chain	X	6PW2801	
* 200mm Belted Chain			
<b>Cross Conveyor</b>			
* Right Hand Discharge			
* Left Hand Discharge	X	6PW6302	
* Reversible Rear Cross			
* Split 24" Cross			
<b>Rear Cross</b>			
* 35" Cross			
* 40" Cross	X	6PW3401	Discharging in middle of Row 1 & 2
* 48" Cross			
<b>Rear Cross Chain</b>			
* 40 mm All Straight SRT			
* 45 mm All Straight SRT	X	6PW3501	
<b>Secondary Star Table Options</b>			
* No Star Table Option			
* 5 Stars with Distributor Stars on the Cross			
* 6 Stars with 2 Adjustable Smooth Rollers and Distributor Stars on Cross	X	6PW2102	
* 6 Stars with 2 Adjustable Smooth Roll and Distributor Stars on Cross, extra Star Roller on left			
<b>Rear Leveling</b>			
* No Rear Leveling	X	6PW6200	
* Rear Leveling			
<b>Gauge Wheels</b>			
* No Gauge Wheels			
* Two Single Gauge Wheels	X	6PW5501	
<b>Vine Separators</b>			
* Double Diak Coulters	X	6PW2900	
* Kickers			

Manufacturing Use Only

AFE Manufacturing Form  
6 Row Pull Type Windrower

Serial Number:  
Customer: T A FARMS LTD  
Dealer: HIV EQUIP

HIV. P.O. # 165576.

PAGE 4 of 5.

3 <sup>rd</sup> Center Assembly			
No 3 <sup>rd</sup> Center			
One Center			
Two Center			

Customer Acceptance: [Signature]  
 Dealer Acceptance: [Signature]  
 AFE Acceptance: [Signature] 12-11-08

Cross Discharging  
In middle of Row 1 & 2

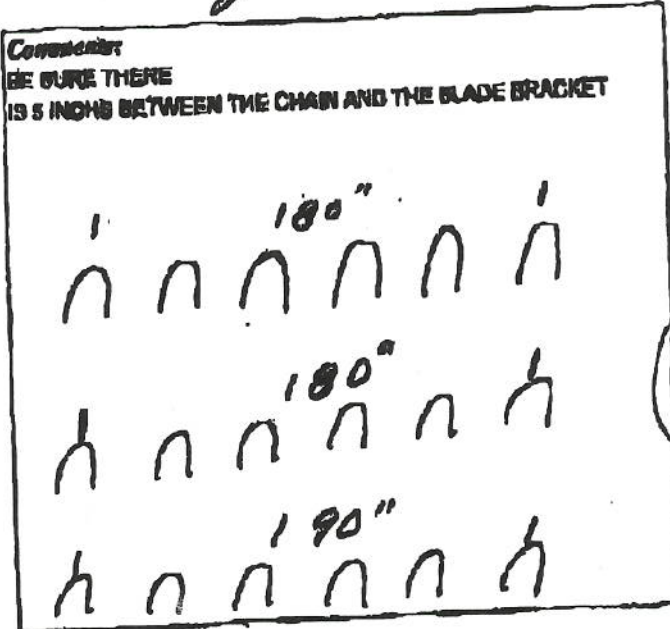

32" Diggen Bed chain  
36" Rows 212" width

34" Diggen Bed chain  
38" Rows 215" width

36" Diggen Bed chain  
38" Rows 226"

Question if you dig 38" Rows  
is 11" ENOUGH ON EACH SIDE OF THE  
CENTER OF THE HILL

CENTER DOG OF EACH BLADE  
SO THE ARE ON 38" ROWS

228"

Manufacturing Use Only

AFE Manufacturing Form  
6 Row Pull Type Windrower

Serial Number: \_\_\_\_\_

Customer: T A FARMS LTD

Dealer: HJV EQUIP

*HMN P.O #165576*

*PAGE 5 of 5.*

Mfg	Chain/Location	Qty	Rod Size	Width	MM	LPR
	Primary	7	0.5	34	56	
	Secondary	3	0.44	69	56	
	Deviner	3	0.65	69	180	
	Cross	3	0.44	40	45	

# AFE New Equipment Chain Verification Sheet

Chain For HJV Equip / T A Farms Ltd. #09035 6RPTWLH

AFE Part #	Description	Quantity	Brand	Location
2003-00503	1/2x34x56mm 2x60 DNPL - 18' 4"	7	Noffsinger	Primary
2003-00504	7/16x69x56mm 3x60 STSRT - 13'	3	Noffsinger	Secondary
2003-00505	5/8x69x180mm 2x60 STSRT - 35'	3	Noffsinger	Deviner
2003-00372	7/16x40x45mm 2x60 STSRT - 55'	1	Noffsinger	Rear Cross

Dealer Rep \_\_\_\_\_

Date \_\_\_\_\_

Customer \_\_\_\_\_

Date \_\_\_\_\_

#09035  
TA Friends LTD  
LRPTM

PULL TYPE WINDROWER

REVISED

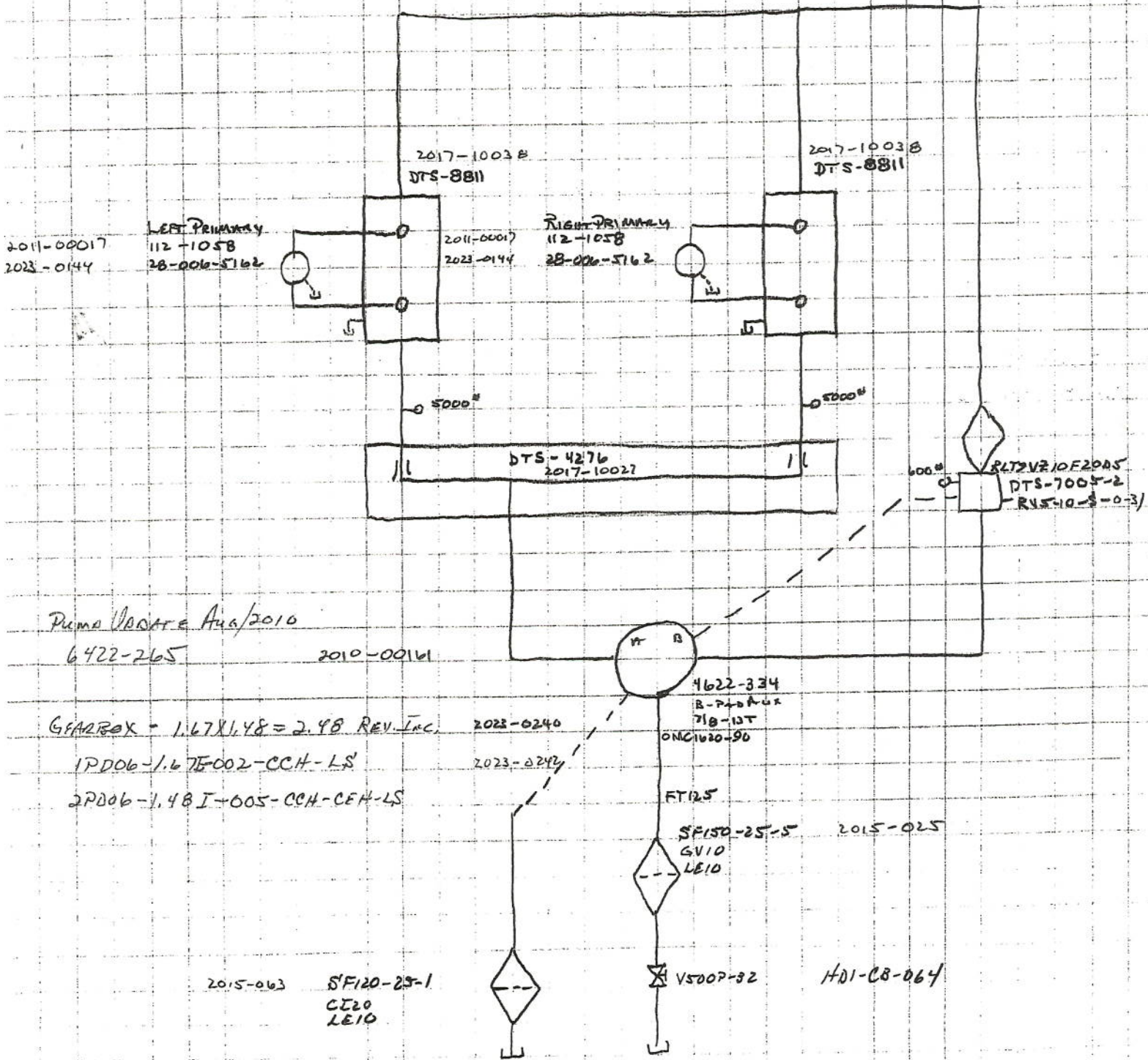

#09035  
 TA FARMS LTD  
 6 RPTW

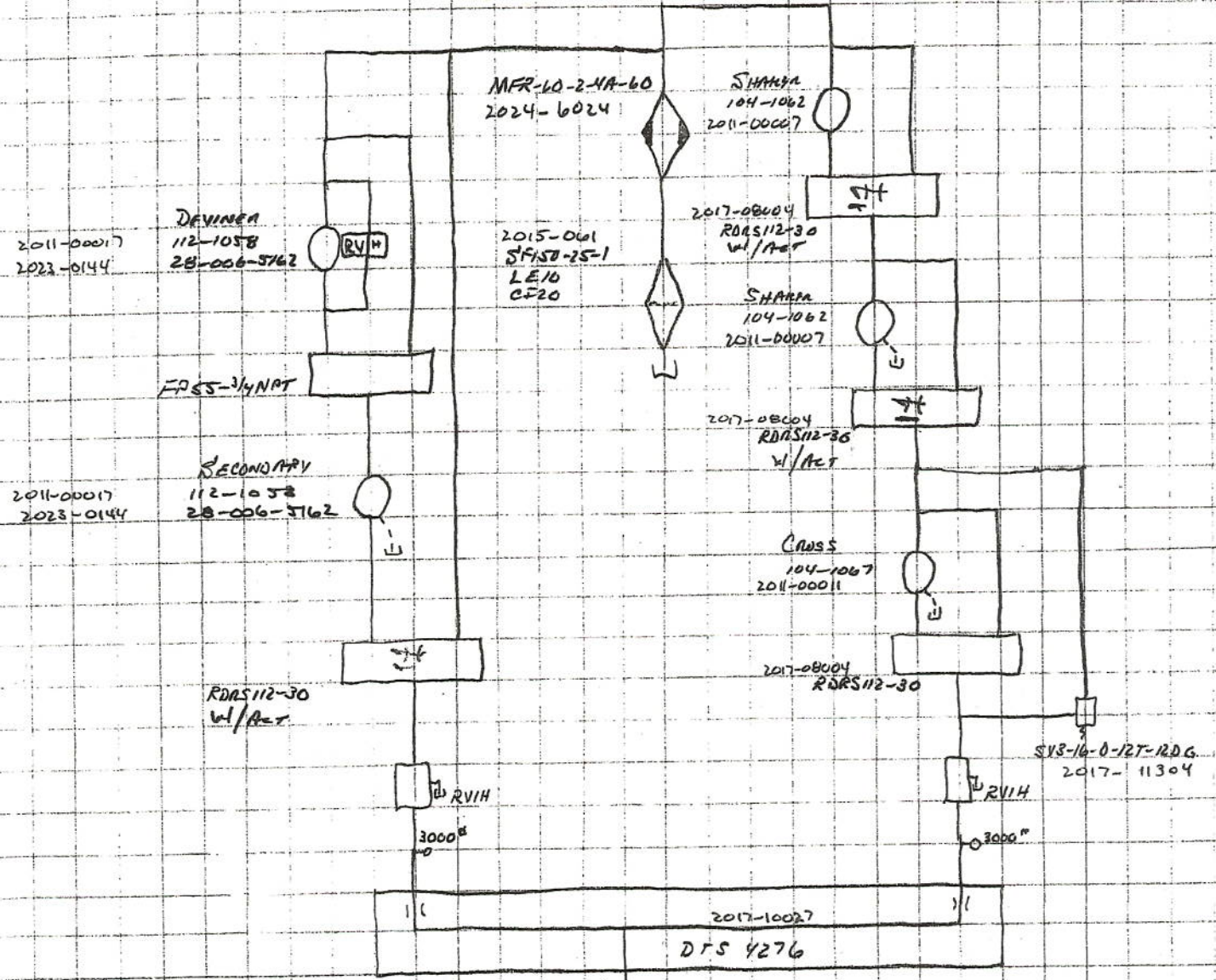

Pump UPDATE Aug/2010  
 3SVQTB25-2297CA20L  
 2010-00184  
 DIVIDER Spool - 60/40  
 FSFD-XBN  
 2017-10062

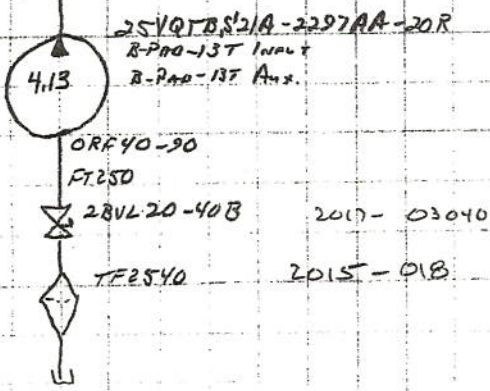

3SVQTB25-2297AA-20R  
 B-PAD-13T Inlet  
 B-PAD-13T Exit

PULL TYPE WIND PUMPER

#09035  
TAFARMS LTD  
WRPTW

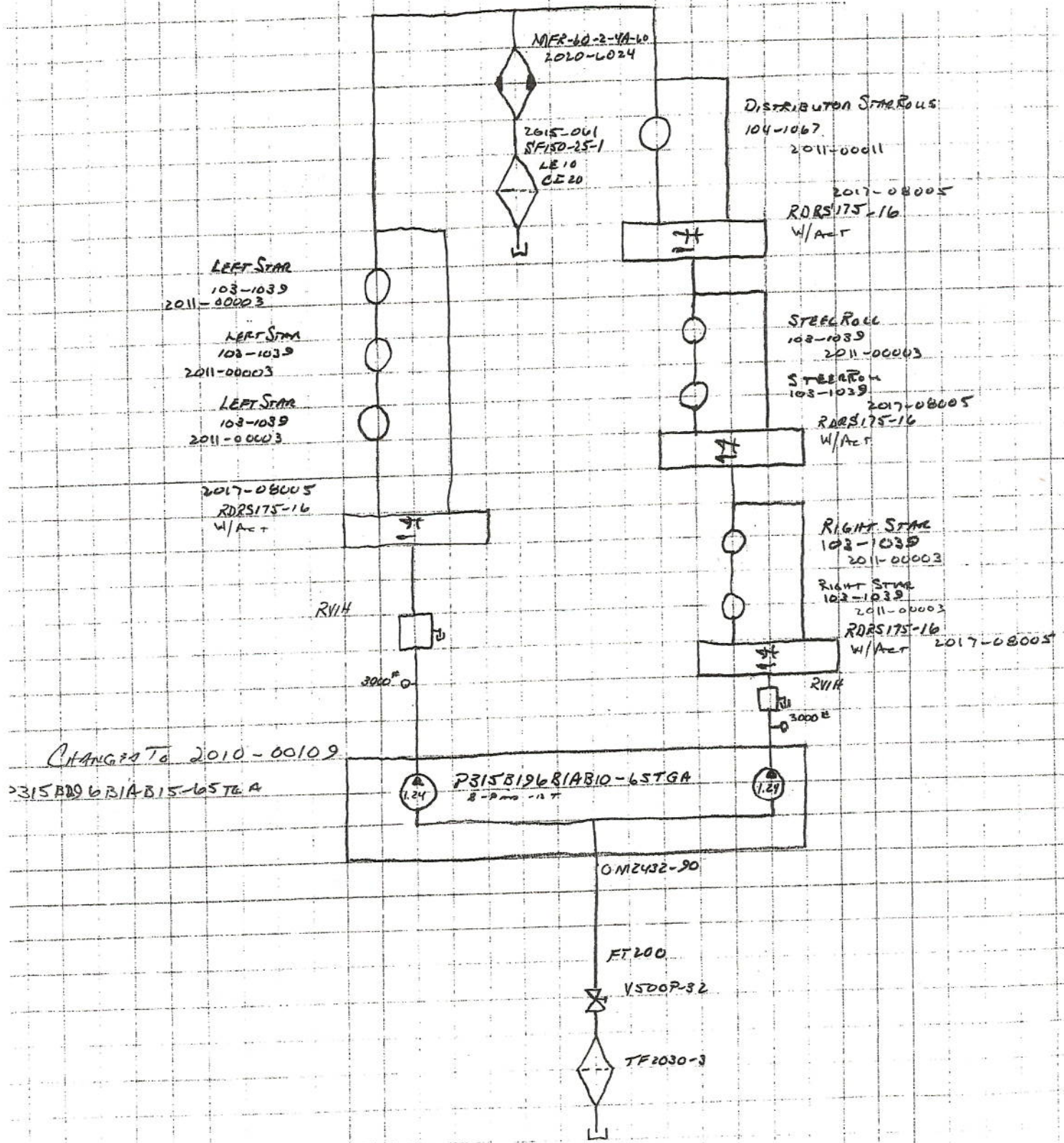

E09085  
 TA FAMES LTD  
 BRPTW

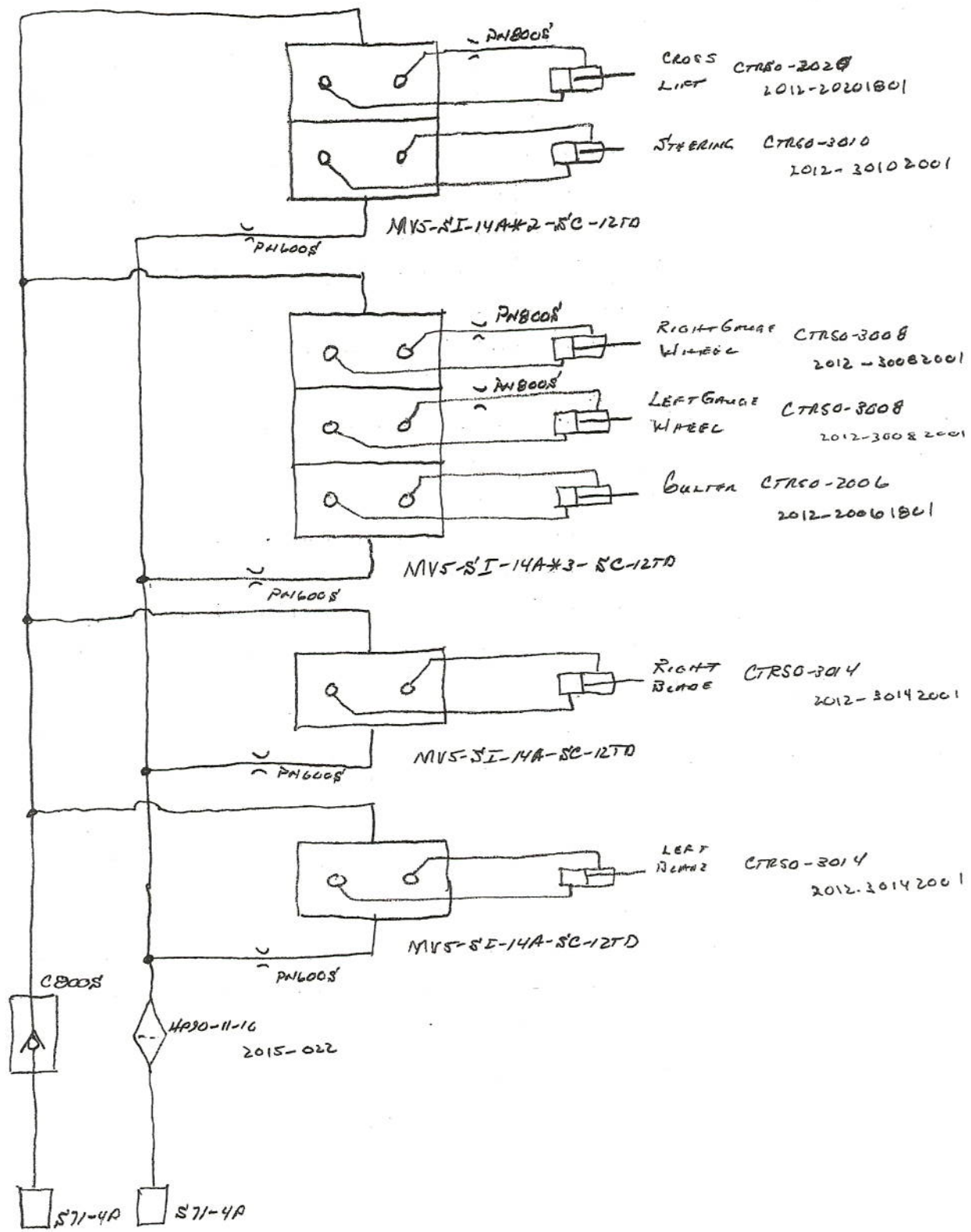



PULL TYPE W/INROWPA

#09033  
TA FARMS LTD  
6RPTV1

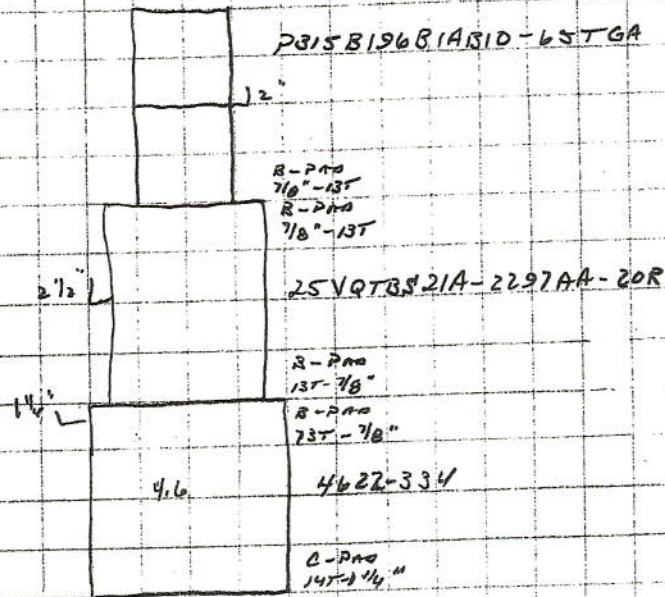

H-DI-CB-069

REVISAO -

6/8/09  
#09035  
TAFARMS LTD  
LRPTM

PULL TYPE WINDROWER

Do NOT USE

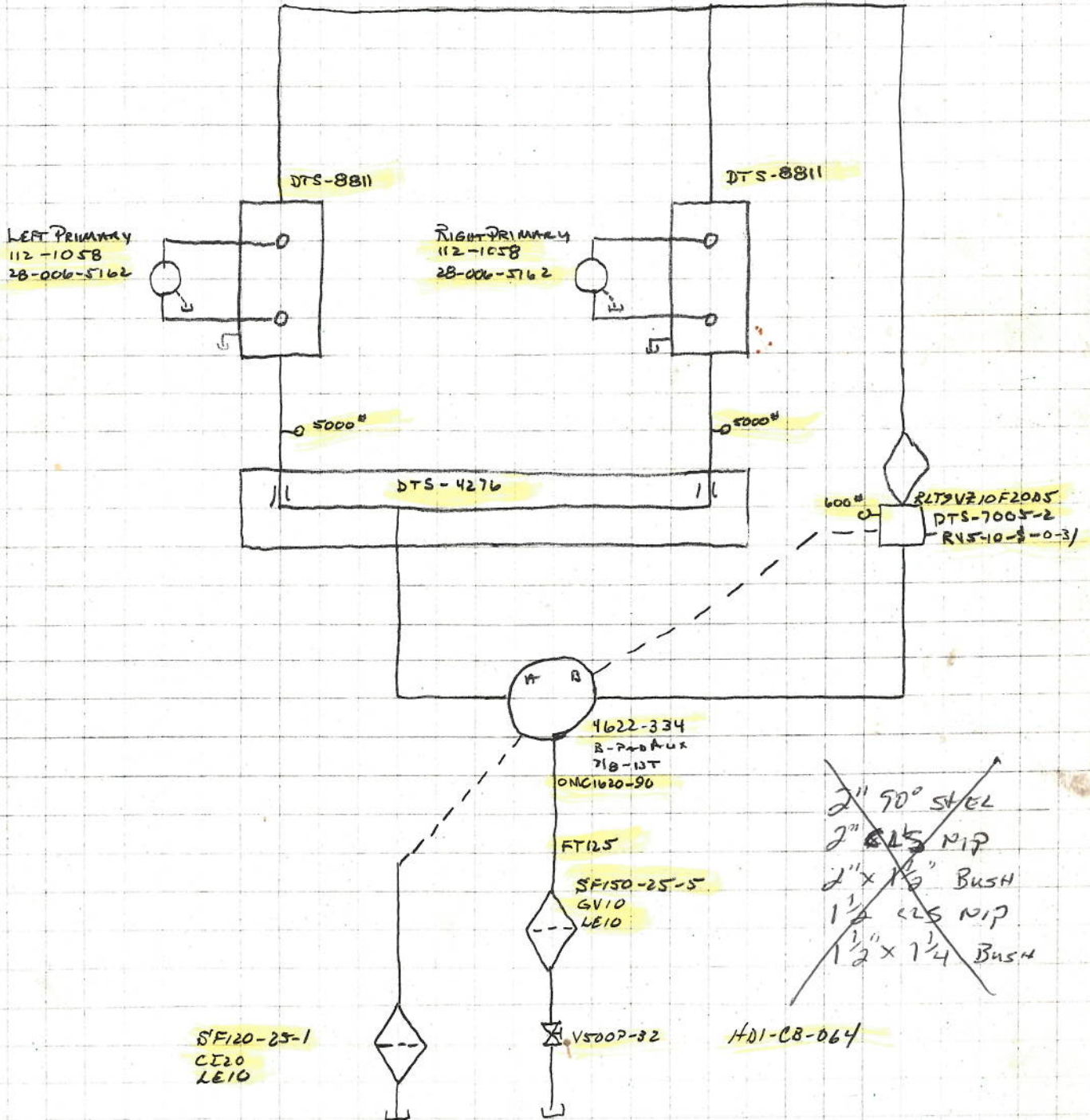

6/8/09  
 #09035  
 TA FARMS LTD  
 6RPTW

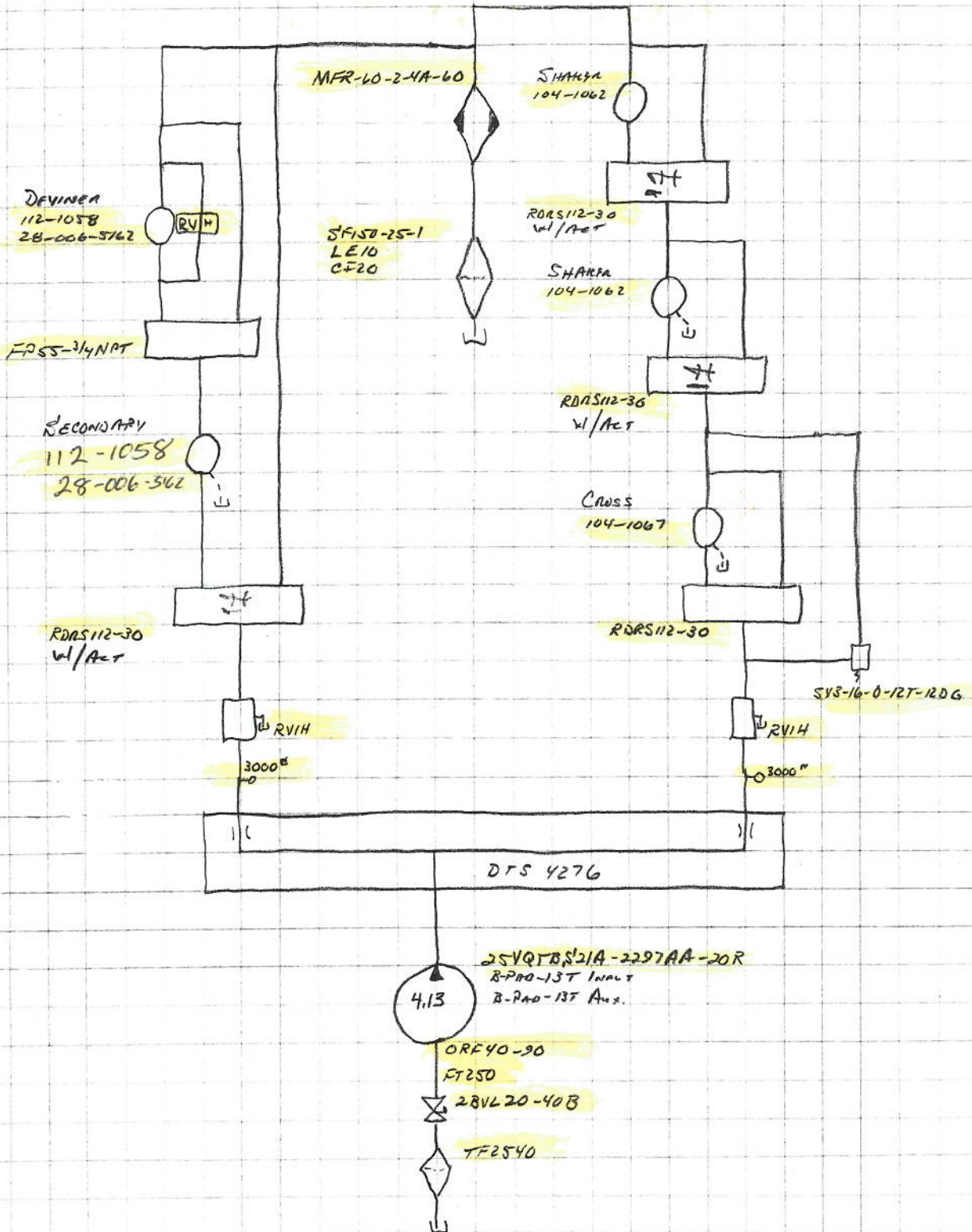

PULL TYPE WINDROWER

6/18/09  
EG9035  
TAFARM LTD  
LRTK1

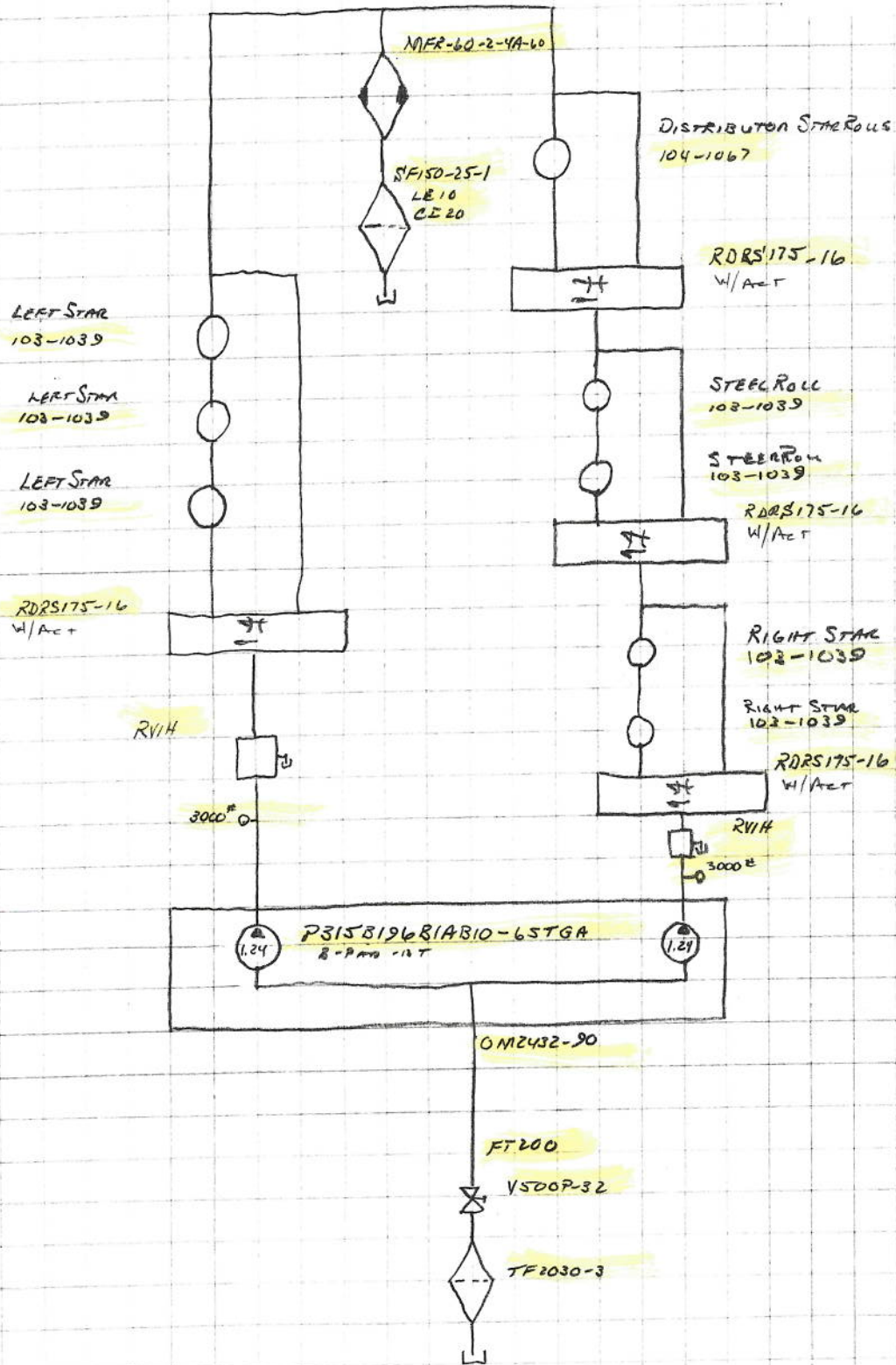

6/8/09  
E09035  
T A FARMS LTD  
6 RPTW

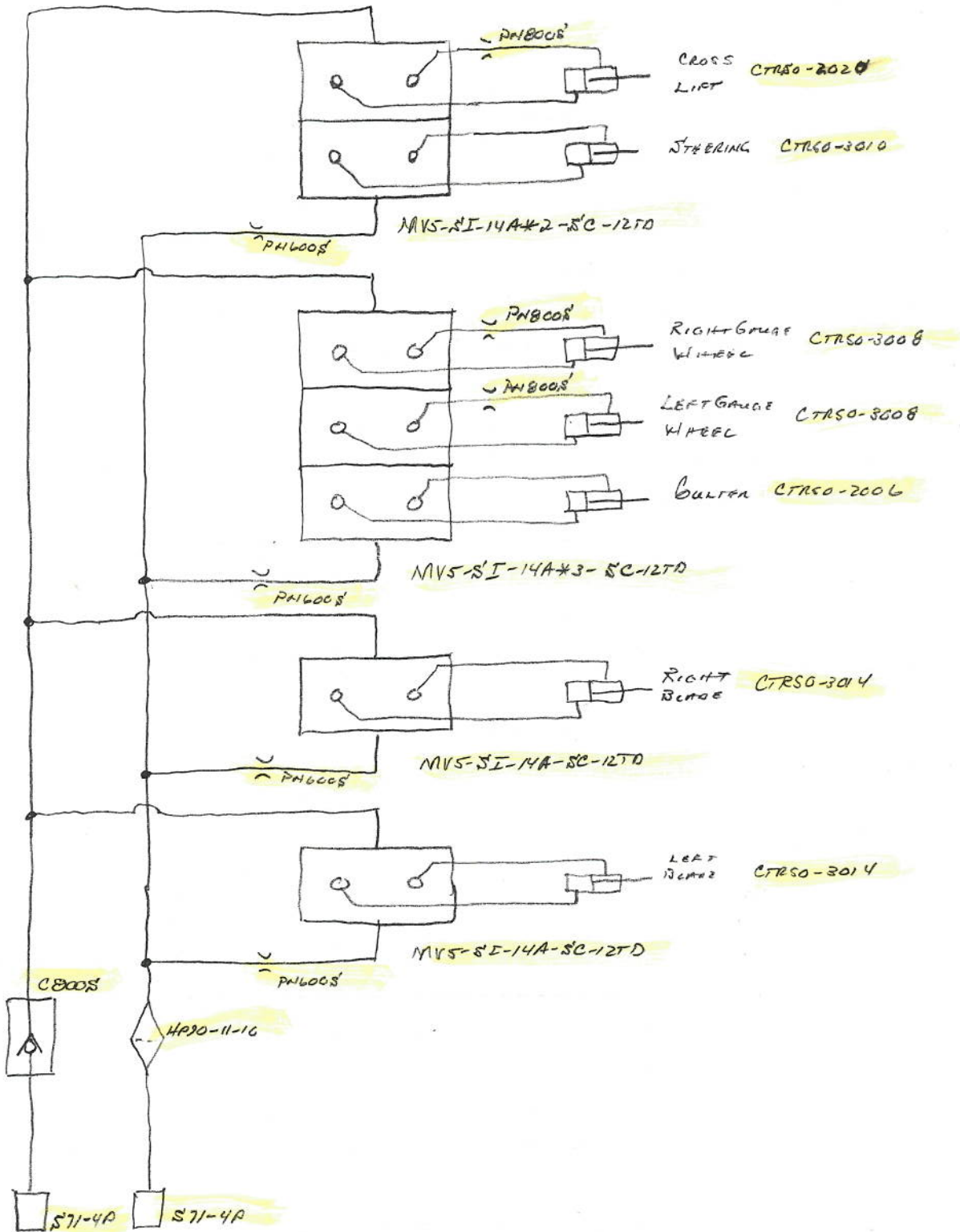

16/8/09  
 #09035  
 TA FARMS LTD  
 BRATVA

Pull TYPE 4/Improving

COOLER

- 1- 3269-24-24
- 1- 1 1/2 45° STEEL
- 1- FT 150

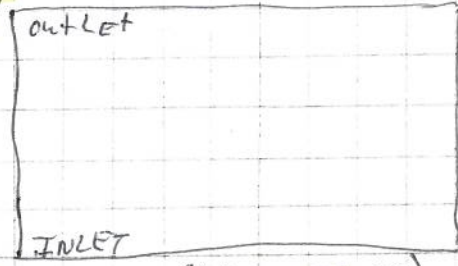

- 1- 3269-24-24 (6405-24-24)
- 2- 1 1/2 45° STEEL
- 3- 1 1/2 TEE
- 3- 1 1/2 CLS NIP
- 3- 16x24 BUSH - HYDRAULIC (24SB 24-16)
- 3- 848FS 12x16

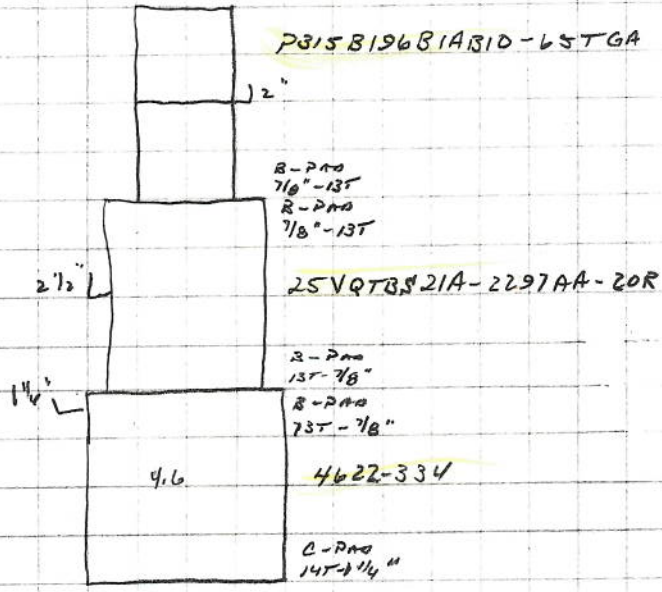

OIL TANK BACK VIEW

OIL TANK OUTSIDE VIEW

- 1- TF2540
- 1- 2 1/2" CLS NIP
- 1- BNL 2040
- 1- FT 250 (INSIDE)
- 1- TF 2030
- 1- 2" CLS NIP
- 1- V500 F32
- 1- FT 200 (OUTSIDE)

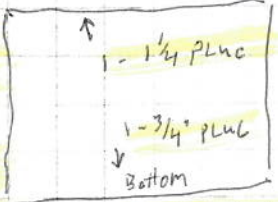

- 1- 2" 90° STEEL
- 1- 2" CLS NIP
- 1- V500 F-32
- 1- 2" x 1 1/2" BUSH

HDI-CB-064

- CAP
- 1- 3/4 x 2" BELL
- 1- BF 12

- 1- 1 1/2 CLS NIP
- 1- SF 150
- 1- 1 1/2 x 1 1/4 BUSH
- 1- FT 125

COOLER RET

- 1- 1 1/2 x 2 BUSH
- 1- 1 1/2 90° STEEL
- 1- 1 1/2 x 5 NIP
- 1- SF 150
- 1- 1 1/2 90° STEEL
- 1- FT 150

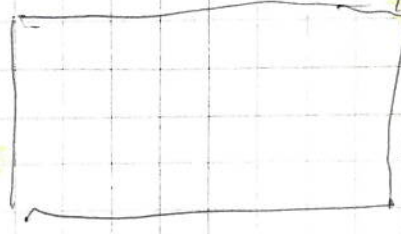

HYDRO FLUSH

- 1- 1 1/2 90° STEEL
- 1- 1 1/2 x 1 1/4 BUSH
- 1- 1 1/2 x 5 NIP
- 1- SF 150
- 1- 1" x 1 1/4 BUSH
- 1- 848FS 12x16



# HYDRAULICS FINISH MATERIALS LIST

BEGINNING DATE  
END DATE

PROJECT NO. 031305

QTY	PART NUMBER	DESCRIPTION
		DIGGER BLADES
		CENTER POINTS
12	2035-04001	TAPERED NOSE CONE ROLLERS
24	2035-00005	5" BLACK ACE
62	2035-00004	4" BLACK ACE
86	2035-07002	1 1/2" STANDOFF
32	2035-03001	R11AY1
26	2035-03000	R11AB1
24	2035-07001	1" STANDOFF
51	2035-01009	3 1/2" STEEL W/5" FLANGE
10	2035-01008	3 1/2" STEEL W/OUT FLANGE
39	2035-01001	3 1/2" KRYP W/5" FLANGE
14	2035-01000	3 1/2" KRYP W/OUT FLANGE
16	2035-01011	3 1/2" RUBBER W/5" FLANGE
8	2035-01010	3 1/2" RUBBER W/OUT FLANGE
1	2035-01004	3 1/2" RUBBER W/ 8" FLANGE
22	2035-H56M12R1	4X PRIMARY / SECONDARY
2	2035-H45M10RB	5X CROSS
2	1/2" x 2" Deck WASHER	
125	5/8-11 x 3 1/2" HHCS	
27	5/8-11 x 5 1/2" HHCS	
36	5/8-11 x 6" HHCS	
2	5/8-11 x 8" HHCS	
10	5/8-11 x 9" HHCS	
2	1/2-13 x 2 1/2" HHCS	
24	1/2-13 x 3 1/2" HHCS	
6	1/2-13 x 4 1/2" HHCS	
13	1/2-13 x 7 1/2" HHCS	
24	1/2- FLAT WASHER	
200	5/8-11 SPIN LOCK NUT	



