

CANTIN

# 11045

4RPTH ~~BAR~~

11/17/16  
 #11045  
 ERIC CANTINI  
 4RPT#

"SEE REVISION"

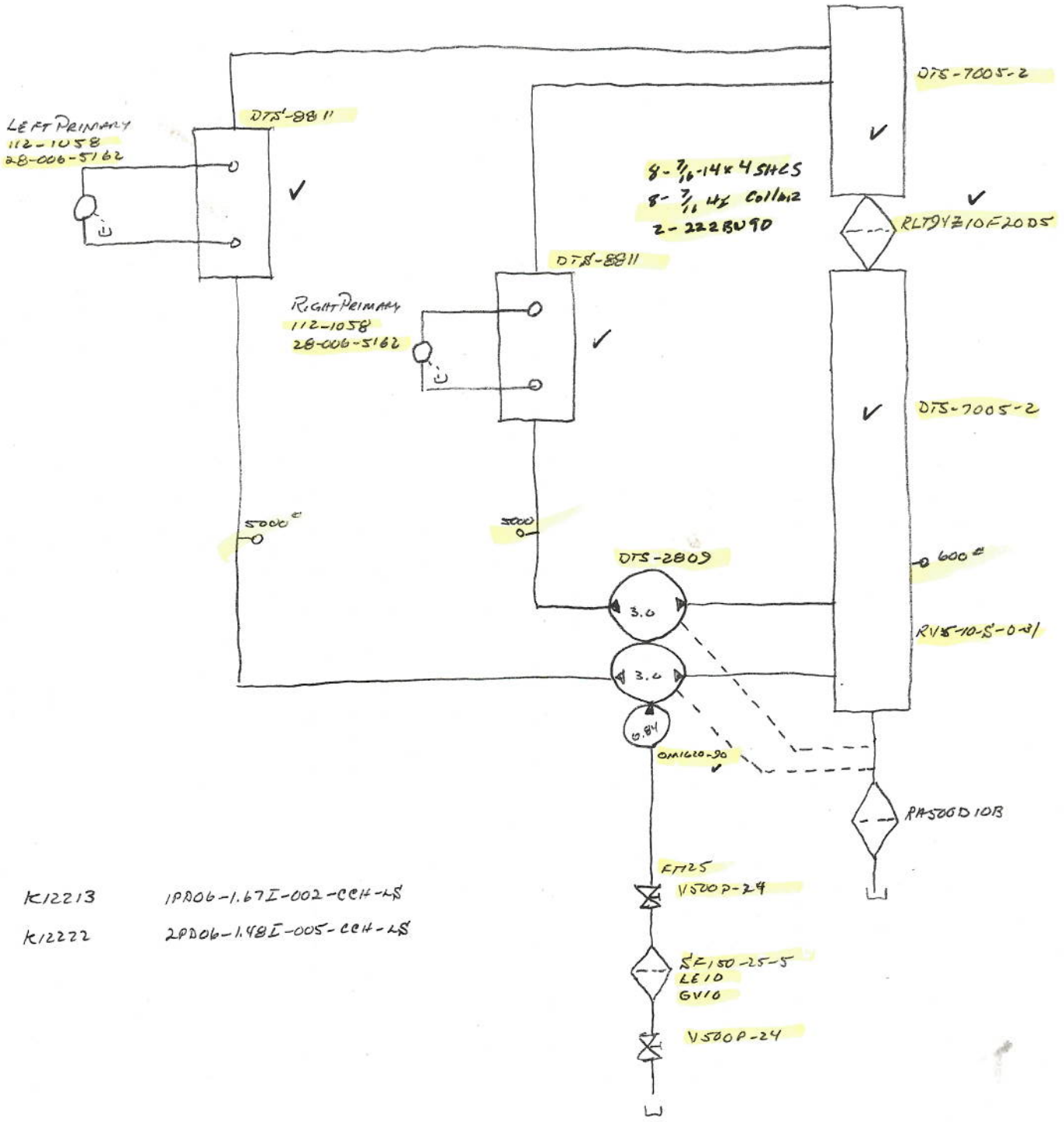

K12213 1PRO6-1.67I-002-CEH-LS  
 K12222 2PRO6-1.48I-005-CEH-LS

11/17/10  
 #11045  
 ERIC CARLTON  
 YRATH

(AIA KNICK) TRANS FAN

PLM 30.73 R0-3355-LOG/OH-N-D-FS  
 615-15R

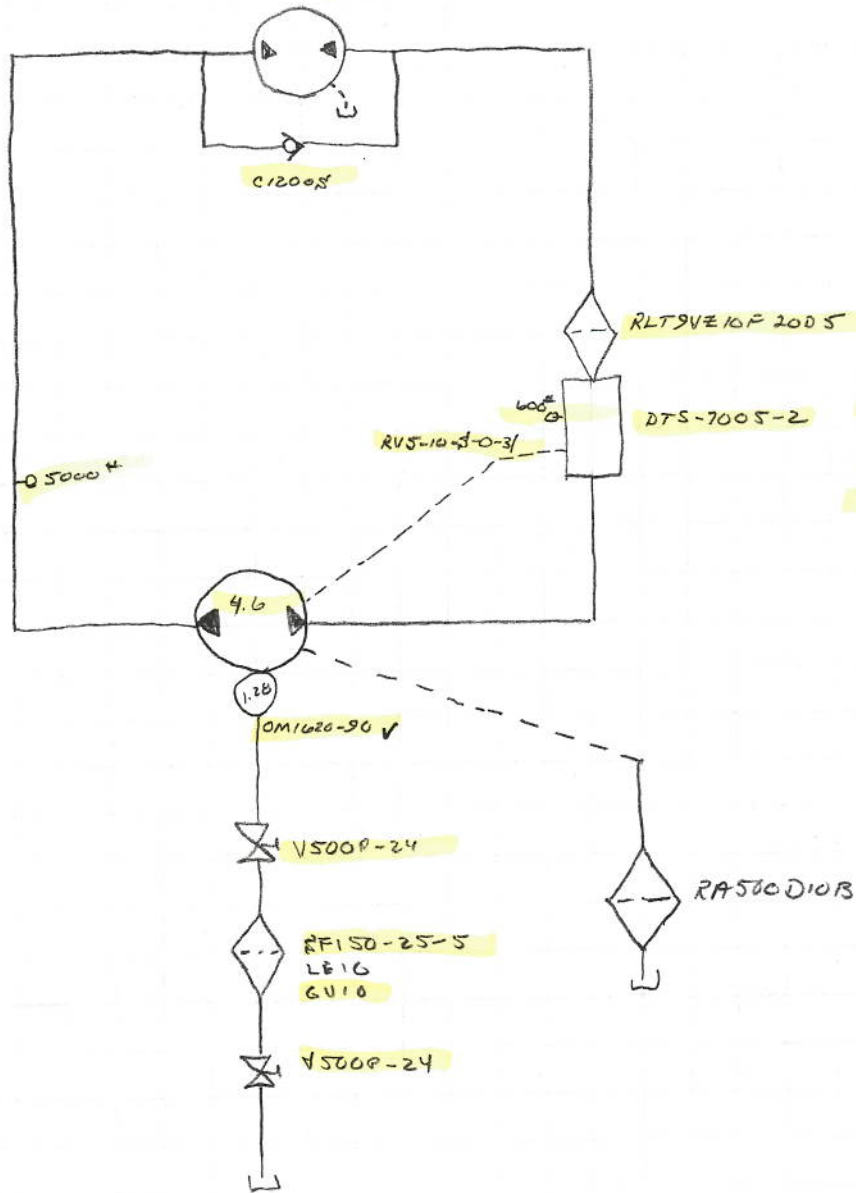

- 4- 7/16-14 x 4 SIKS
- 4- 3/16 NICK COLLAR
- 1- 222BN90
- 4- 7/16-14 x 1 1/4 NICK GR8

12/2/10  
 #11045  
 ERIC CANTH  
 HRATH

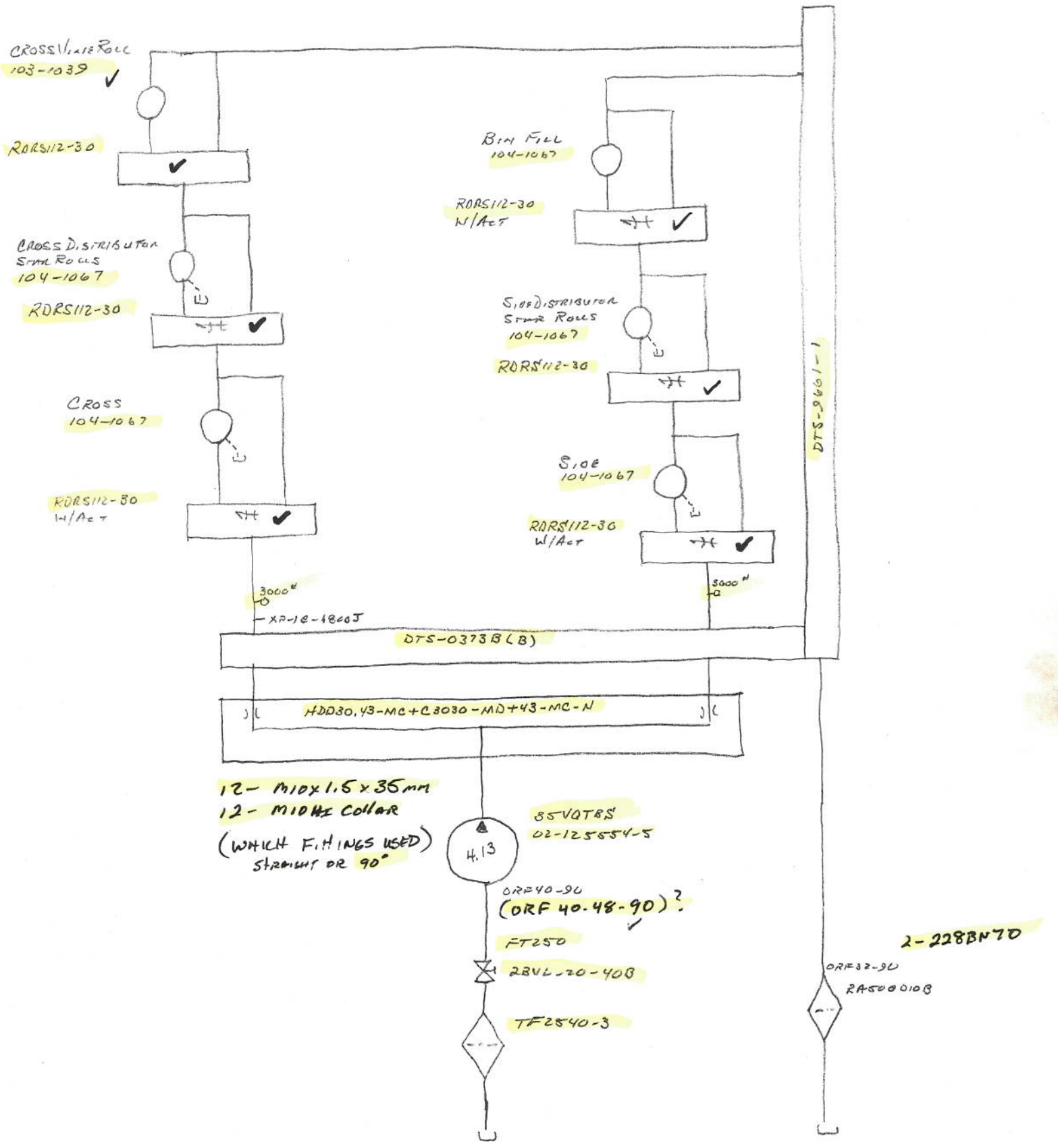

11/17/10 #11045  
 ERIC CARTER  
 4RPT4

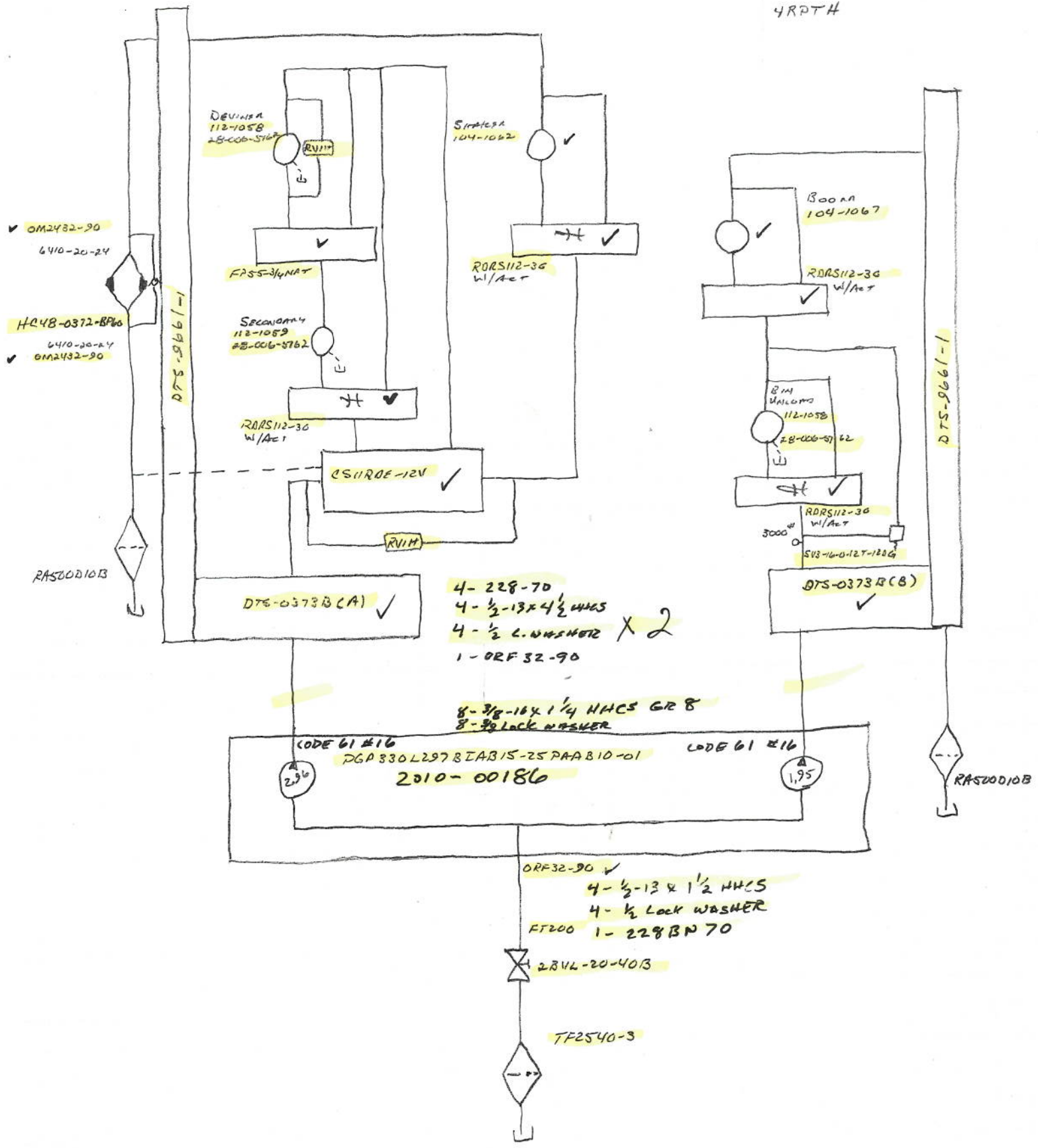

11/17/10 #11045  
ERIC PANTIN  
WRATH

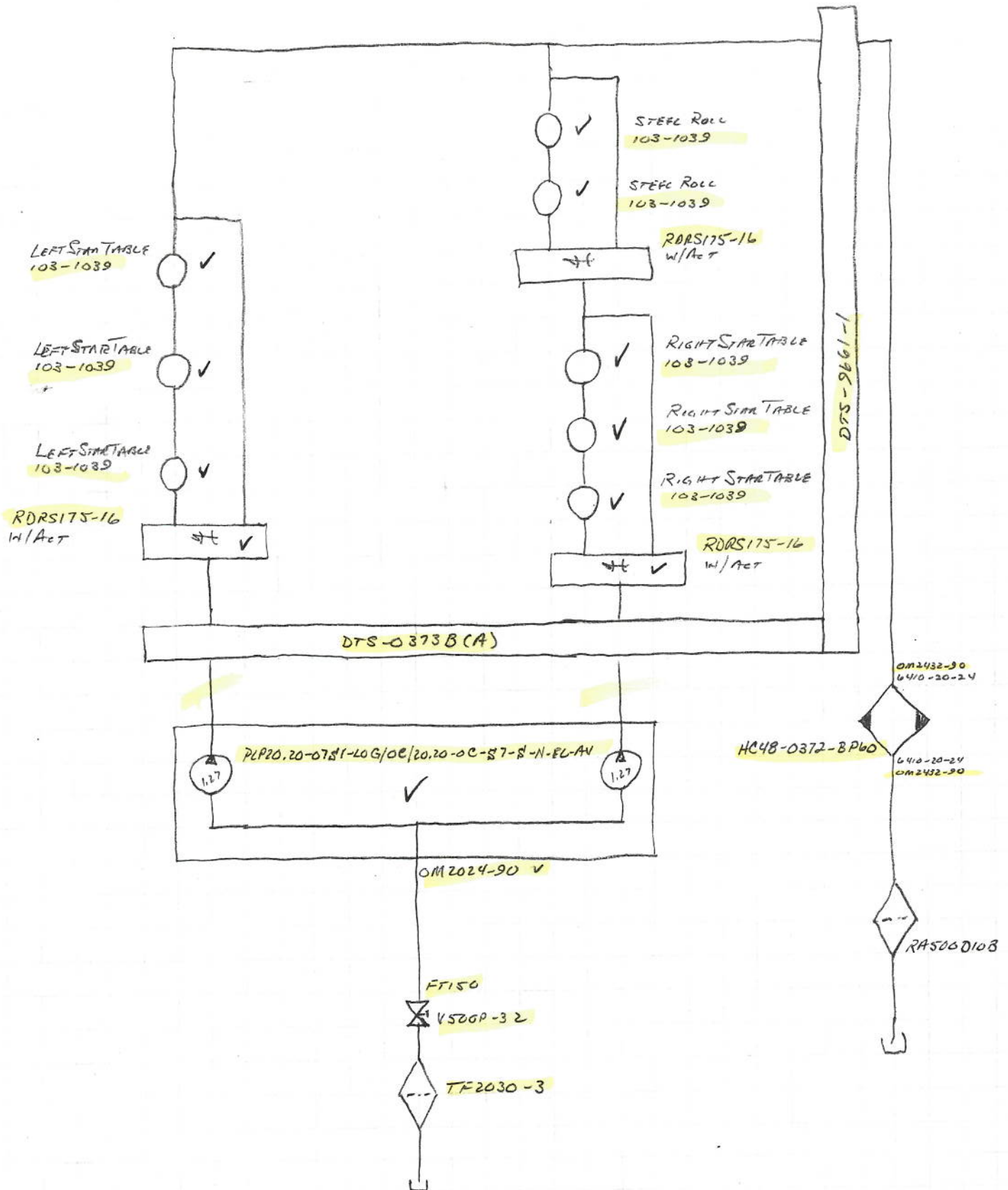

12/6/10  
 #11045  
 ERIC CAHILL  
 4RTH  
 REVISIONS  
 #1 - 12/01/10  
 DRAFT CONTROL  
 ADD FDCI-8 LINE  
 #2 - 12/11/10  
 GAUGE W/HP CYCLE

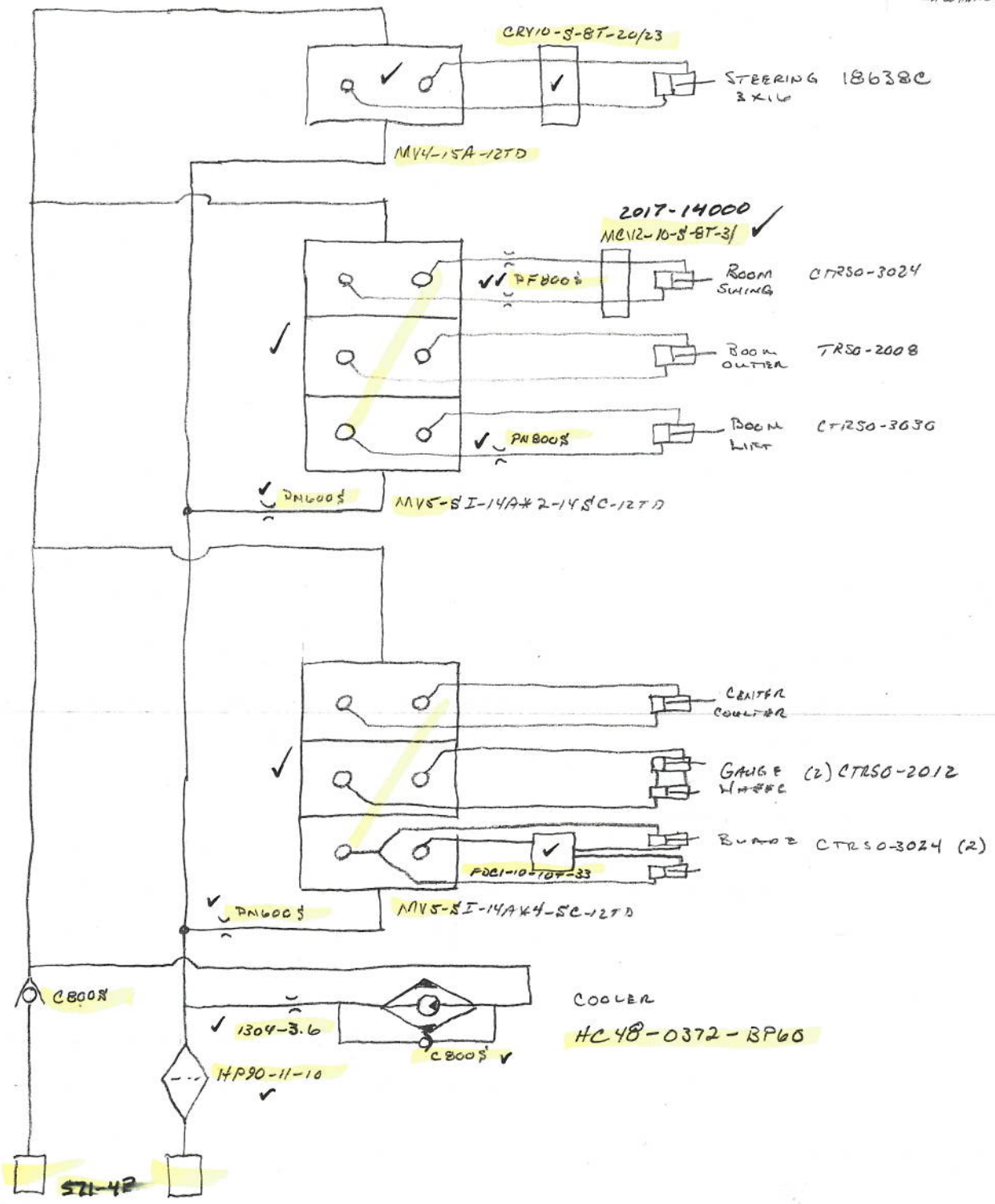

- ✓ 1) 2017-05013
- ✓ VAL 6110-300A
- ✓ 1- PN600S
- ✓ 1- CTRSO 302 3010

11/17/10 to 11/04/5  
ERIC CATMAN  
4 RATU

4" FWM ✓

(4")

- TF2540-3 ✓
- 2 1/2" 90° STEEL
- 2 1/2" CUS NIP
- 2BVL-20-40B ✓
- FT250
- \* 35VQTBS

3" FWM ✓

(3")

- TF2030-3 ✓
- 2" 90° STEEL
- 2" CUS NIP
- 1/500P-32 ✓
- 2" X 1 1/2" BUSH
- FT150
- \* PLP20.20/20.20

(2")

- 2" 90° STEEL
- 2" X 1 1/2" BUSH
- 1 1/2" CUS NIP
- 1/500P-24
- 1 1/4" X 1 1/2" BUSHING
- FT125 FT125
- 5F150-25-5 ✓
- 1 1/2" CUS NIP
- 1/500P-24
- 1 1/2" X 1 1/4" BUSH
- FT125
- \* T3.0/3.0

(3")

- 3" X 1 1/2" BUSH
- 2" 90° STEEL
- 2 X 1 1/2" BUSHING
- 1 1/2" CUS NIP
- 1/500P-24
- 1 1/4" X 1 1/2" BUSH
- 1 1/2" CUS NIP
- FT125 FT125
- 5F150-25-5 ✓
- 1 1/2" 45° STEEL
- 1 1/2" CUS NIP
- 1/500P-24
- 1 1/2" X 1 1/4" BUSH
- FT125
- \* 4.6

4" FWM ✓

(4")

- TF2540-3 ✓
- 2 1/2" 90° STEEL
- 2 1/2" CUS NIP
- 2BVL-20-40B ✓
- 2 1/2" X 2" BUSH
- FT200
- \* RGP330

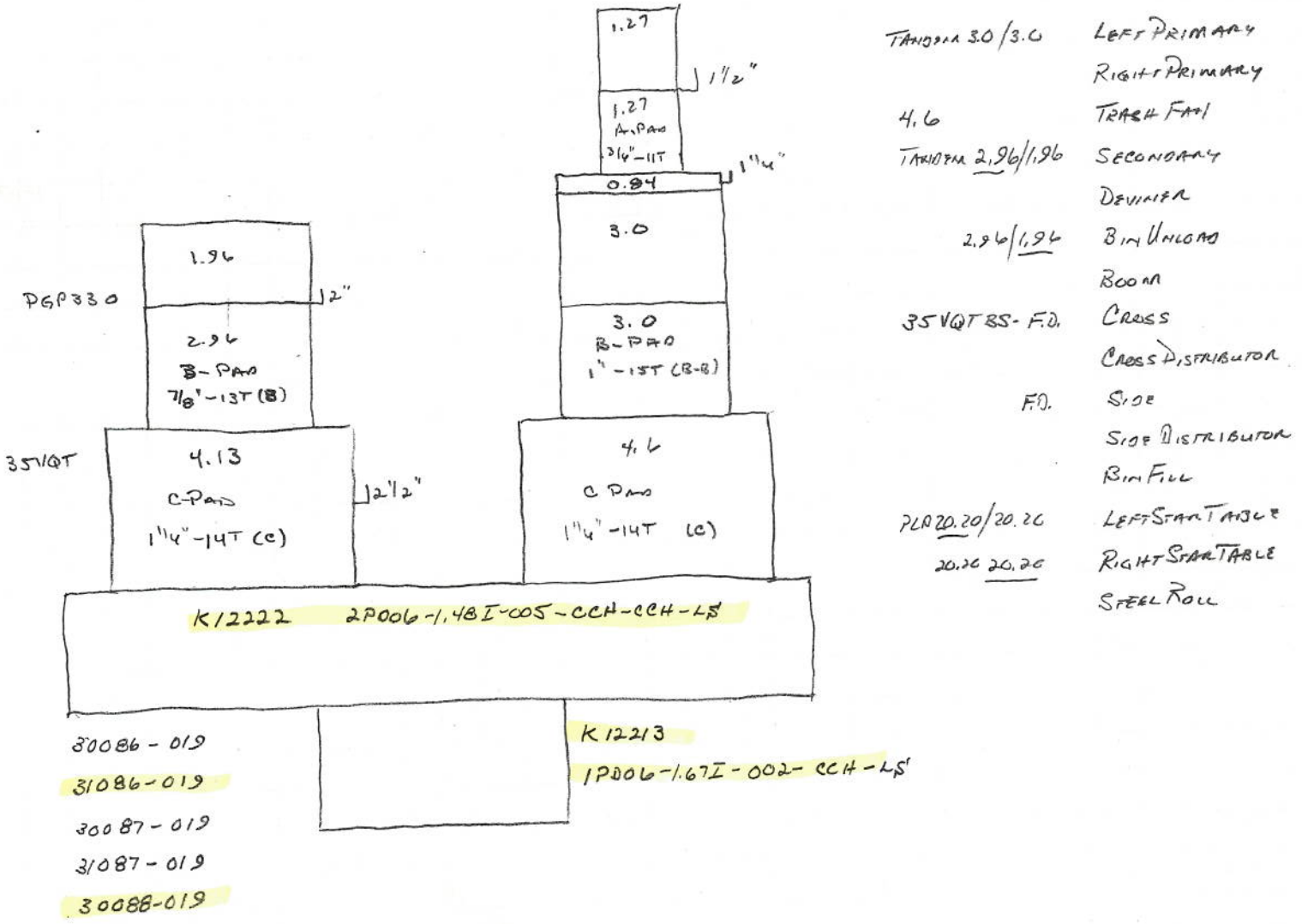



ROW PULL HARVESTER

11102

