

~~#1008~~/~~#1009~~ Schroeder

4 RSPH w/40" AH

2010-00015
02-341865
411AK 00124A

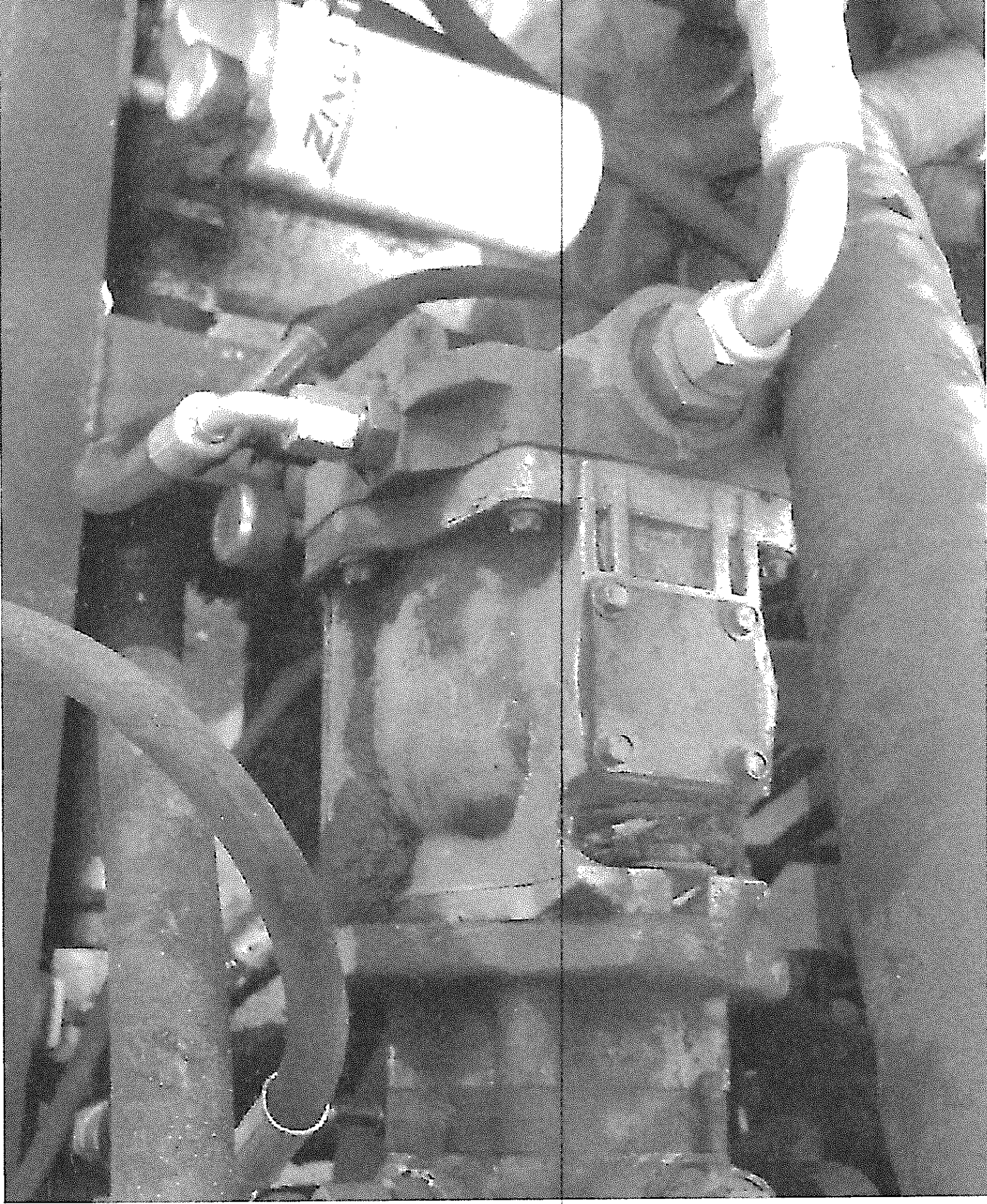

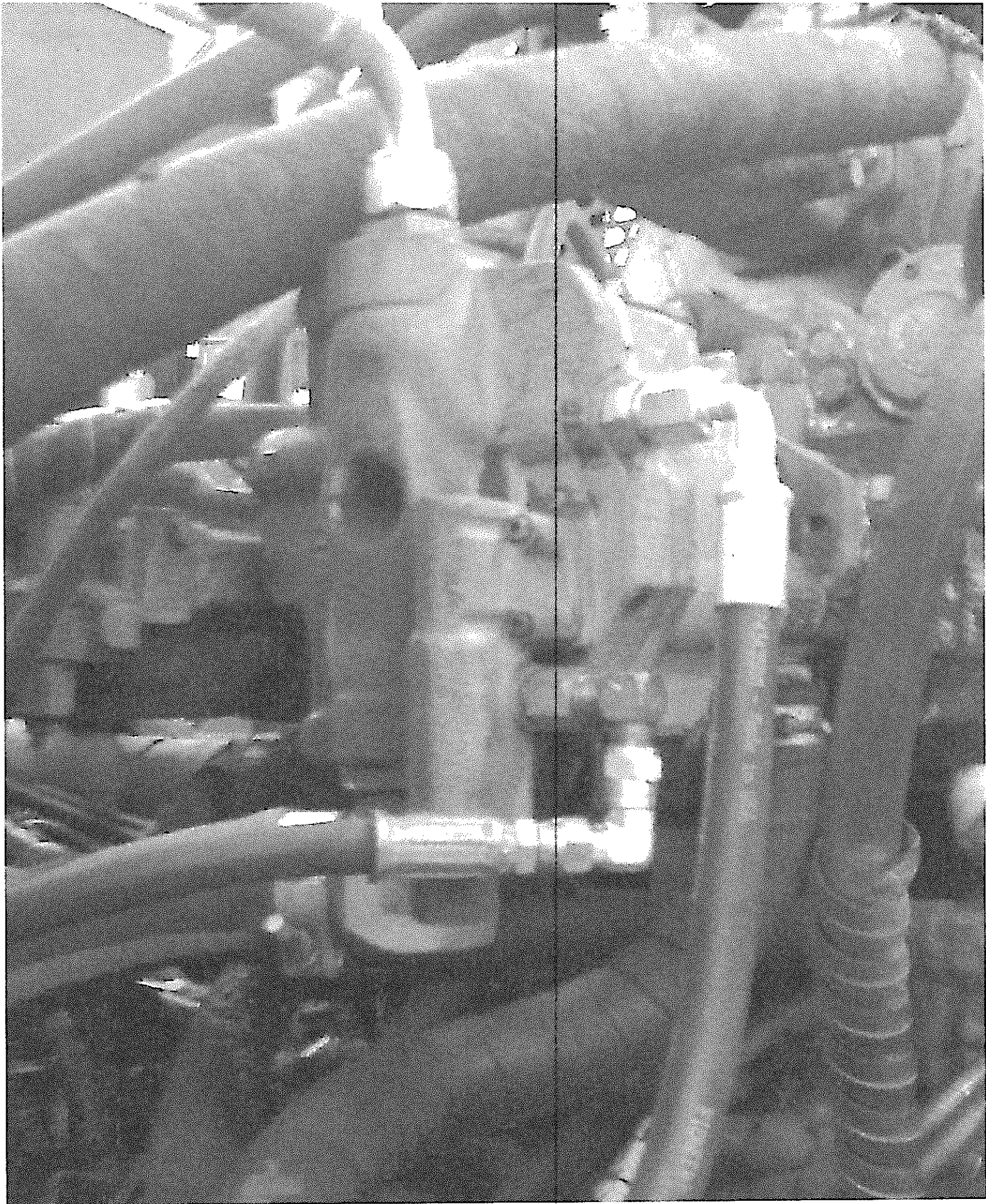

Fischer-Flack, INC.

CORPORATE HEADQUARTERS

2115 RUST AVENUE • P.O. BOX 1508
SAGINAW, MICHIGAN 48605 • 517/752-4181

6585 N. Jerome
P.O. Box 229
Alma, MI 48801
517/463-6104
FAX 517/463-1967

119 W. Fletcher
Alpena, MI 49707
517/356-3411
FAX 517/356-1138

303 W. Water St.
Flint, MI 48502
313/235-6420
FAX 313/235-8904

3201 Bay City Rd.
P.O. Box 1687
Midland, MI 48640
517/496-3600
FAX 517/496-3044

2415 24th St.
Port Huron, MI 48060
313/985-8183
FAX 313/985-8183 Ext. 22

MICHIGAN WATTS 1-800-968-4181 • FAX 517-752-0538

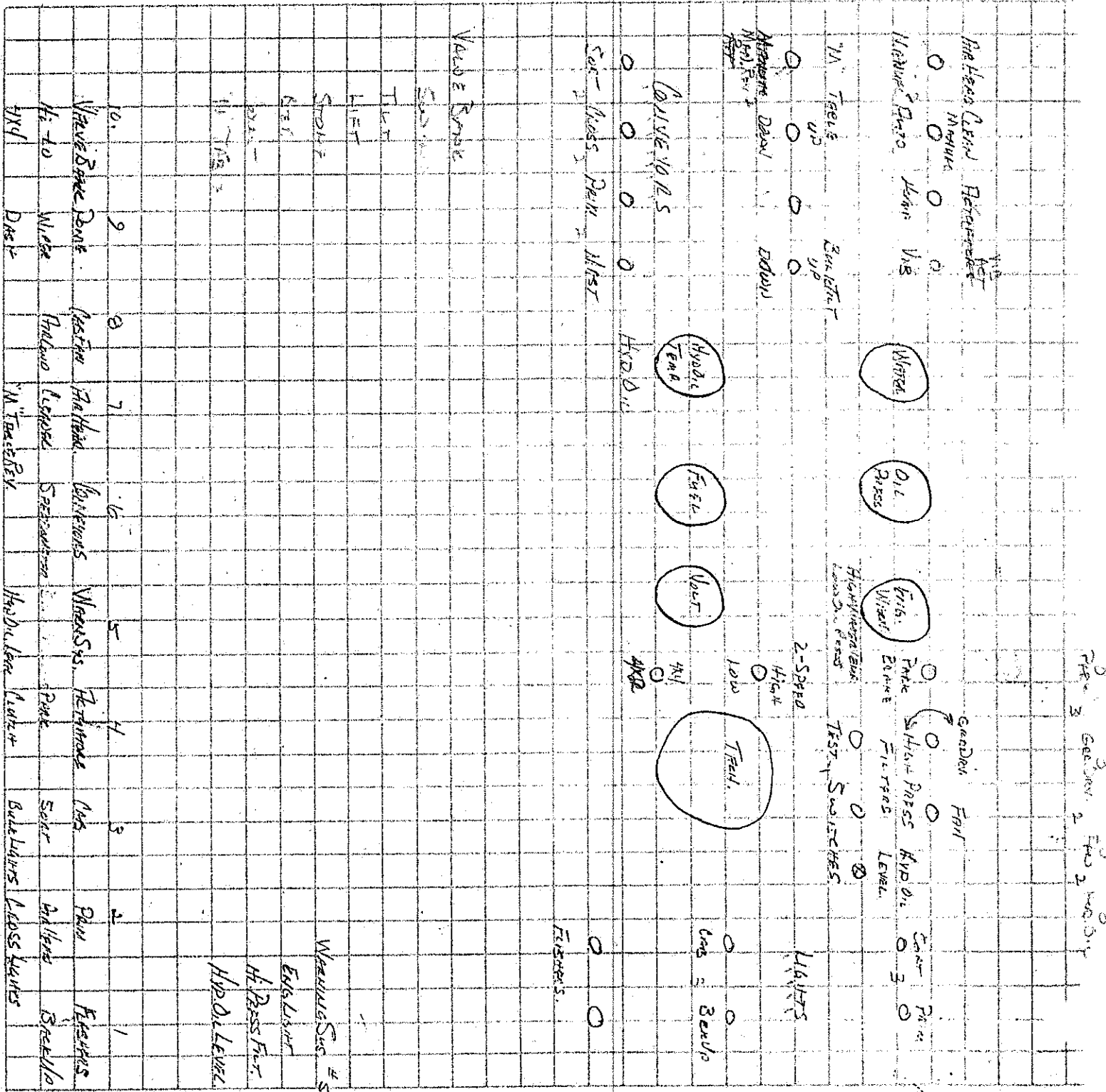

ABRASIVES / GRINDING-CUTTING FLUIDS / CUTTING TOOLS - MACHINE TOOLS
ELECTRICAL APPARATUS AND SUPPLY / FLUID POWER / INDUSTRIAL RUBBER PRODUCTS / RESIDENTIAL
AND COMMERCIAL LIGHTING / MATERIAL HANDLING / POWER TRANSMISSION

GROUND DRIVE SYSTEM

4 ROW 2 WHEEL DRIVE

2" SQ. STEEL MANIFOLD

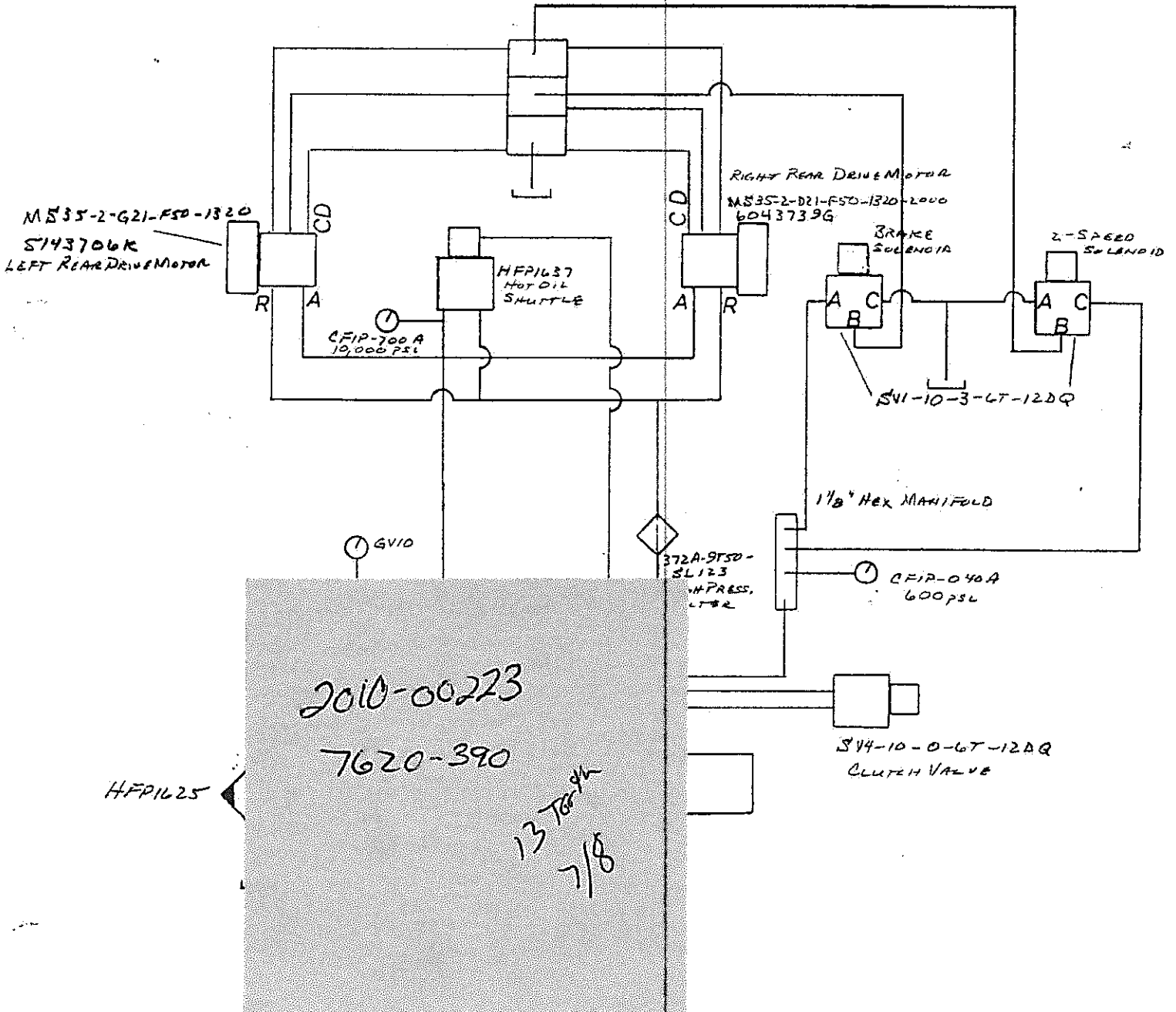

FAN SYSTEM

33 HYDRO PUMP

9/25/90

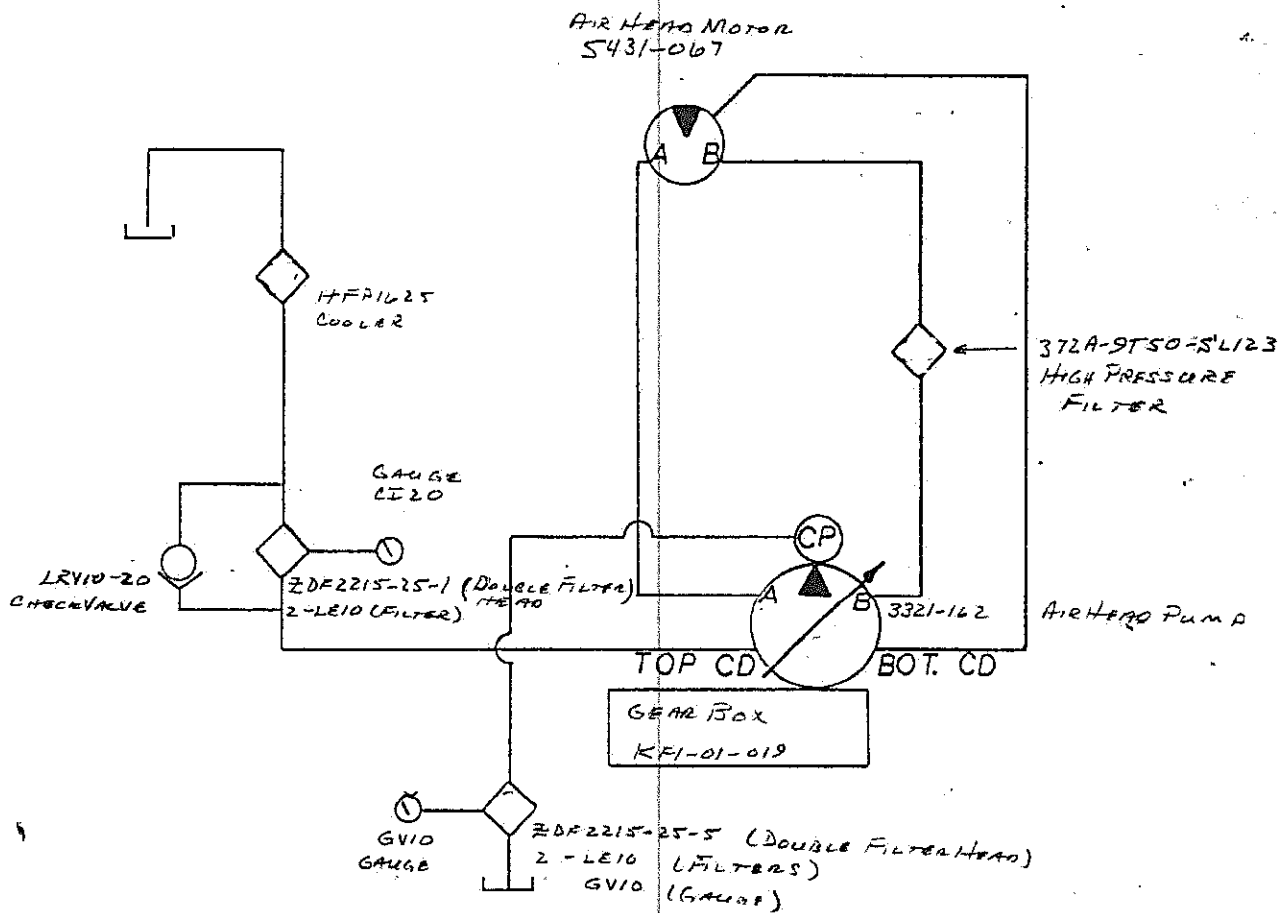

PRIMARY SYSTEM

9/25/90

4 RS PH

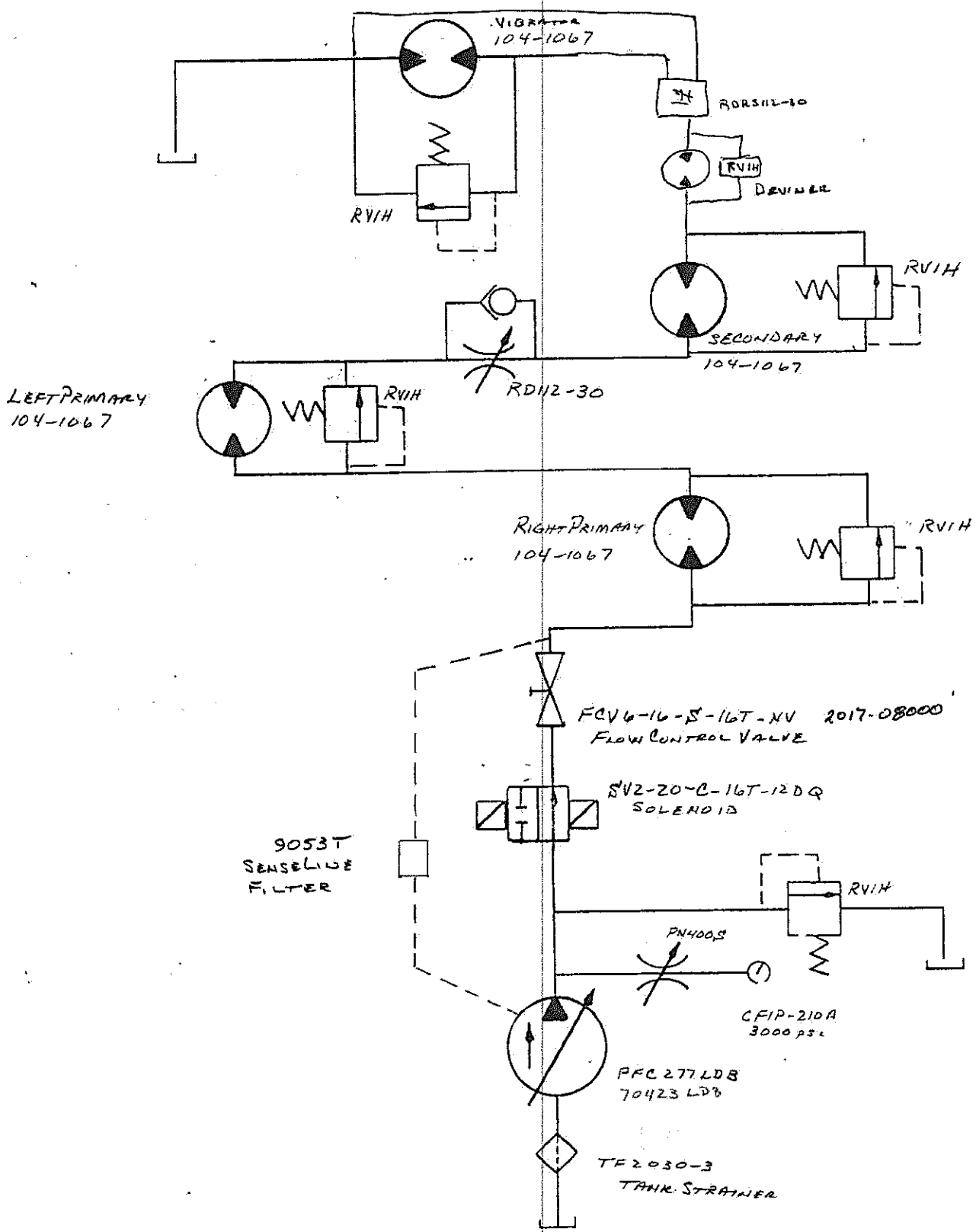

CROSS & SORT SYSTEM

4 RSPH W KICKERS

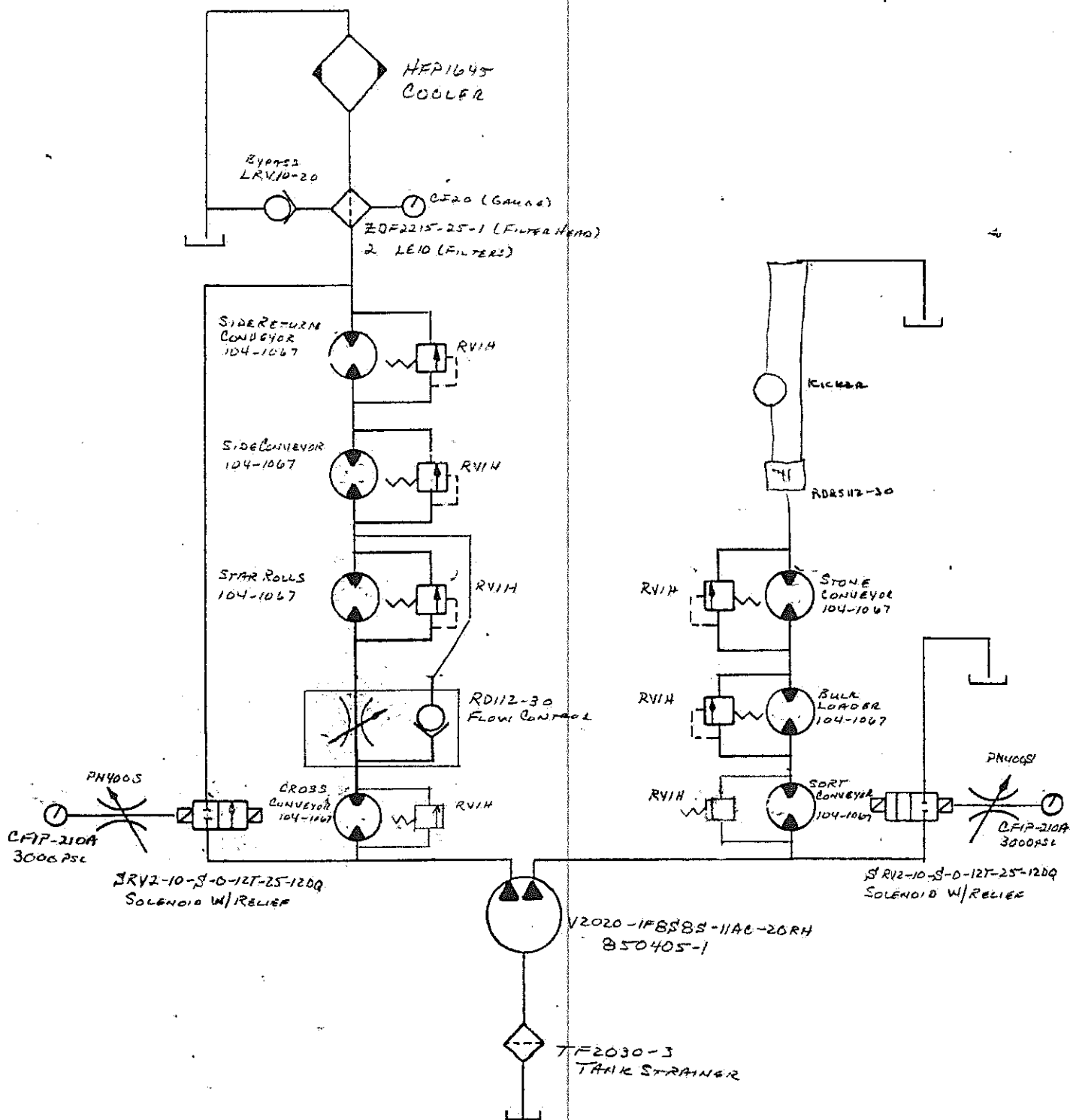

CYLINDER SYSTEM

AIR, W/O KICKERS

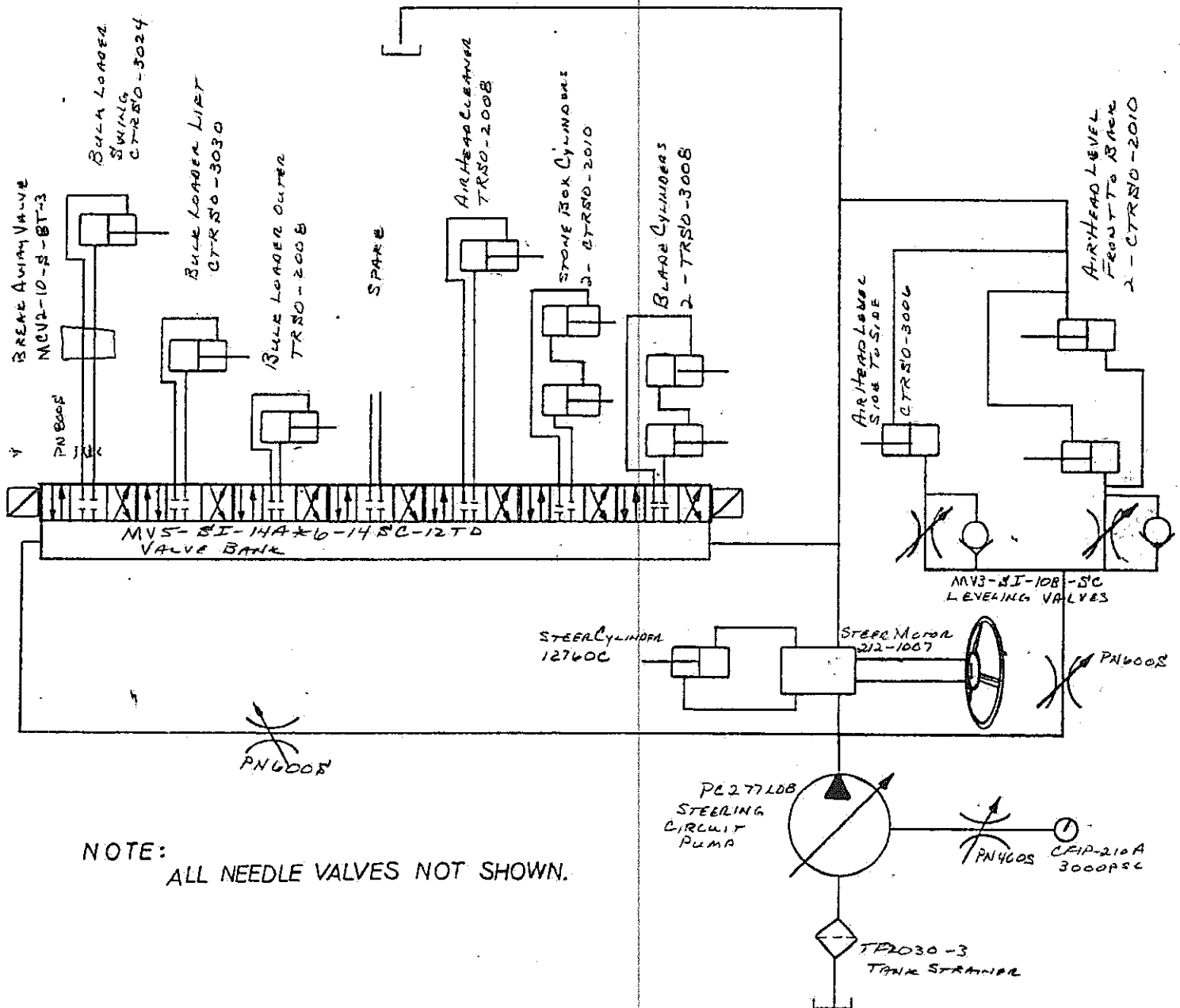

NOTE: ALL NEEDLE VALVES NOT SHOWN.