

#09057

HJV

4 RSPH $\frac{1}{65}$ " AH

A. H. FAN



FILTER WARN



GROUND DRIVE

LOW

HYDRAULIC

OIL

Hi RANGE



Lo RANGE

GROUND

DRIVE

4X4



412

FUEL PUMP



PARKING BRAKE



OFF

FLASHERS



STROBE

LIGHT

FLASHERS

FUEL PUMP

H/Lo RANGE

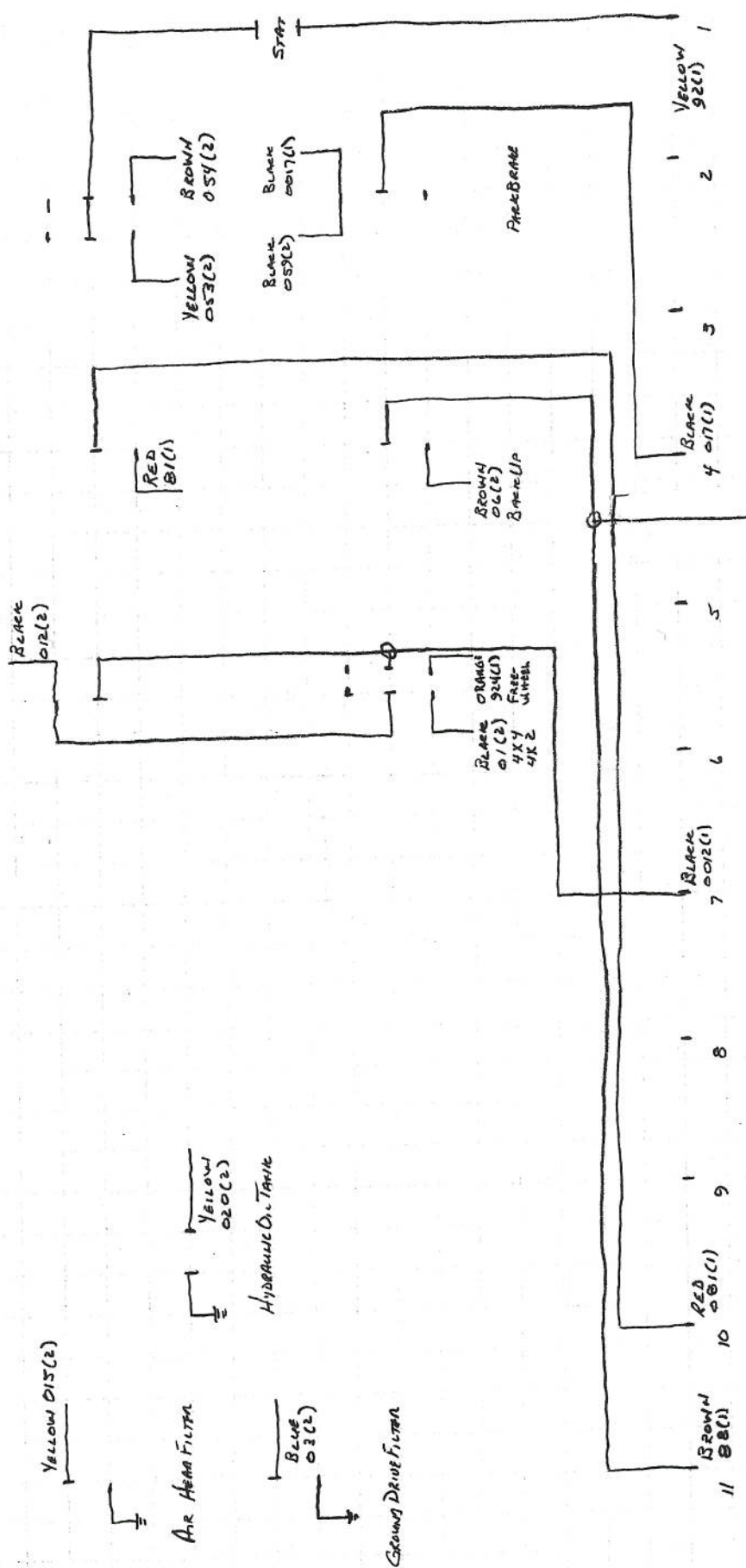

202022 - 202022 + 9112 + 11 + 11

CANTONE DISPLAY

- CAS BEAME
 - PIN 1 BLACK
 - 2 CLEAR
 - 3 BLACK 015 (P)
 - 4 RED 028 (P) + 12VDC
- DISPLAY
- PIN 1 BLACK 015
 - 2 RED 028
 - 7 CLEAR
 - 8 BLACK

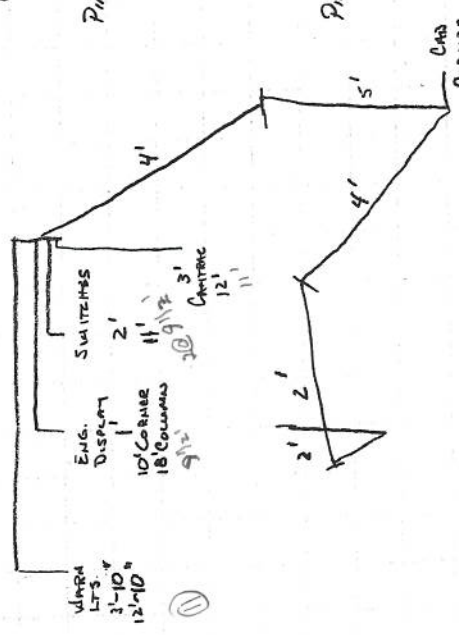

STROBE LIGHT

CAS CORNER

CAS CORNER

FOOT PEDAL SWITCHES

CENTERING

S T E E R I N G

UPPER
SECONDARY

R E V E R S I N G

LEFT

RIGHT

LEFT
PRIMARY

RIGHT
PRIMARY

CENTERING

(STEERING COLUMN)

FOOT PEDAL SWITCHES

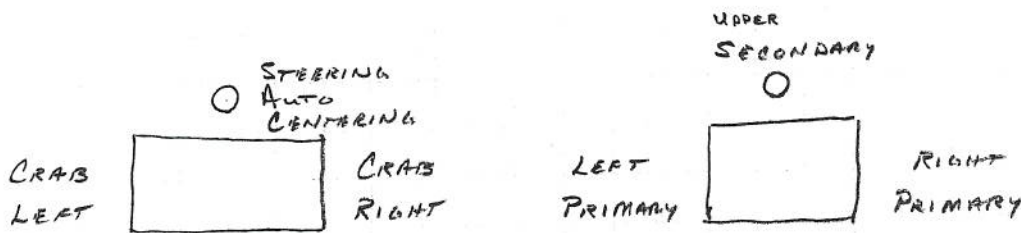

1/4" - 5' + 5' + 4'
1/2" - 5'

STEERING REAR AXLE

REVERSING VALVES

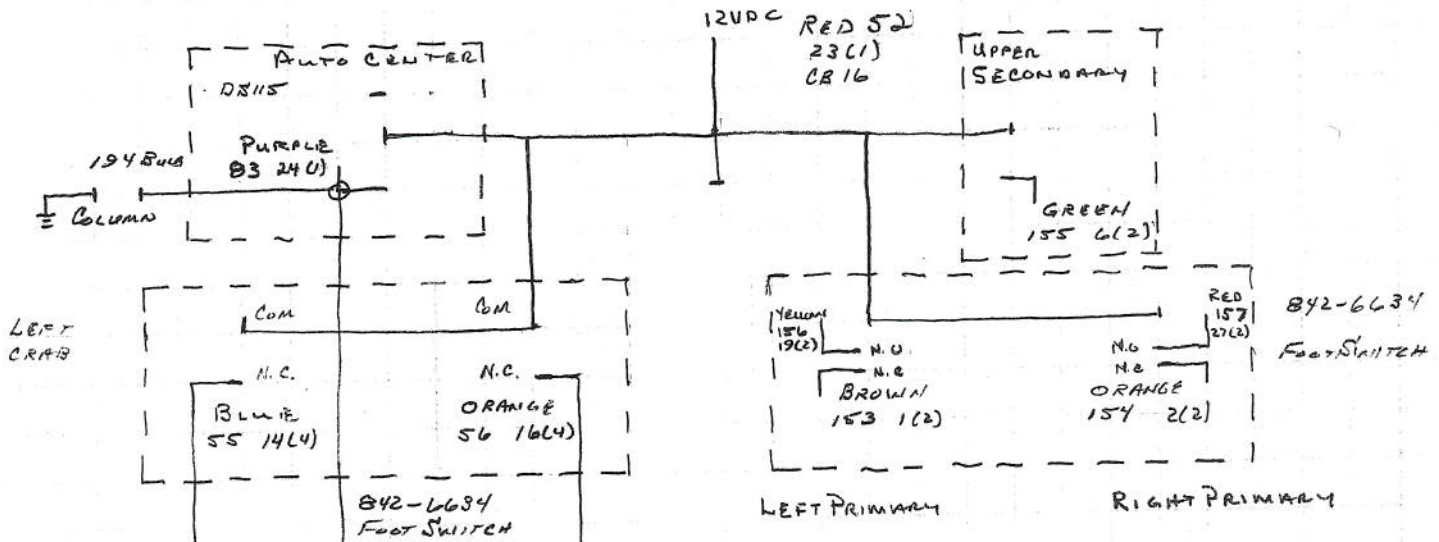

REVERSING VALVES

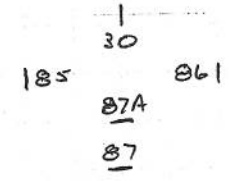
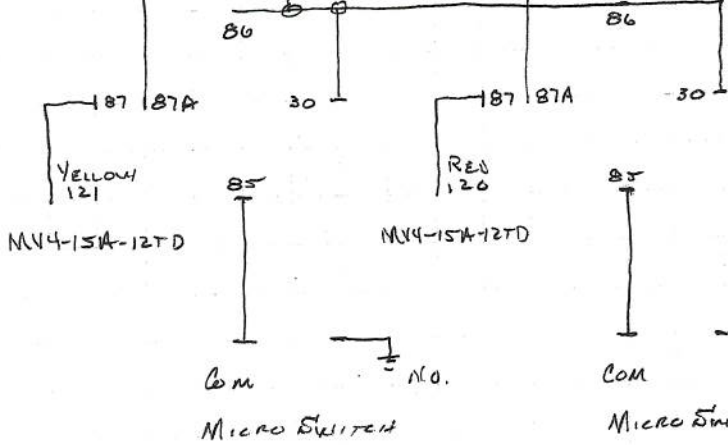

- RIGHT WHEEL #2 (Box Front)
- LEFT WHEEL #2 (Box Rear)
- LEFT WHEEL #1 (Box Front)
- RIGHT WHEEL #1 (Box Rear)

JUNCTION TO COLUMN 6 FT
SWITCHES TO CABINISMENT 7 FT.

Air Head Cleaner

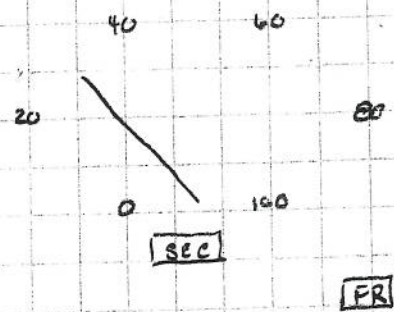
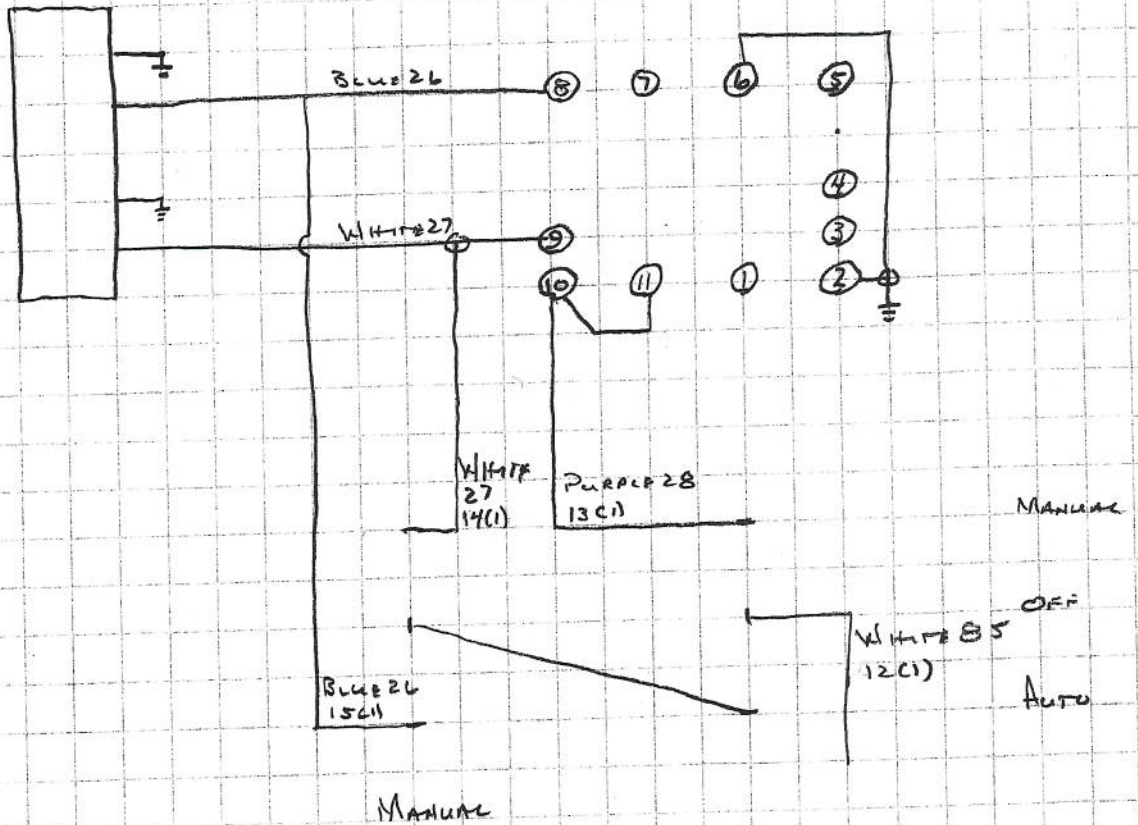

DRAWING NUMBER
99000297

REVISIONS		
REV	DATE	BY
0	1/24/07	EAS
0	1/26/07	JED

Released for Prototype
RELEASED FOR PRODUCTION

Key Switch Connector/Detail
Insertion View Shown

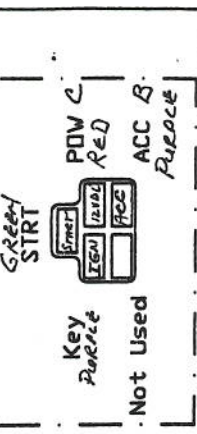

- WARNING: LAMP'S CIRCUIT BOARD
- 1 WHITE MTS
 - 2 RED REL
 - 3 BLUE WIF
 - 4 YELLOW CEL
 - 5 BLACK GND-D
 - 6 PURPLE ACC-D
- Pin 1 WHITE MTS
Pin 2 RED REL
Pin 3 BLUE WIF
Pin 4 YELLOW CEL
Pin 5 BLACK GND-D
Pin 6 PURPLE ACC-D

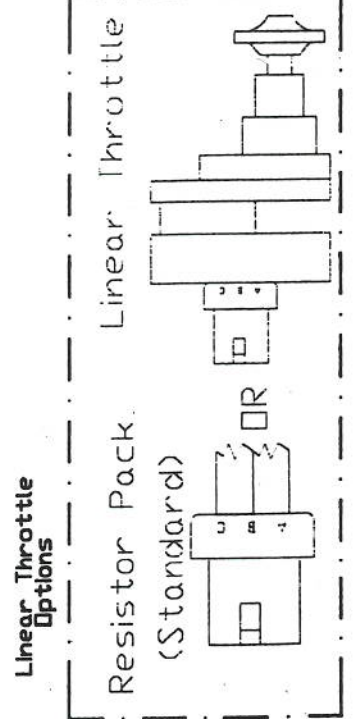
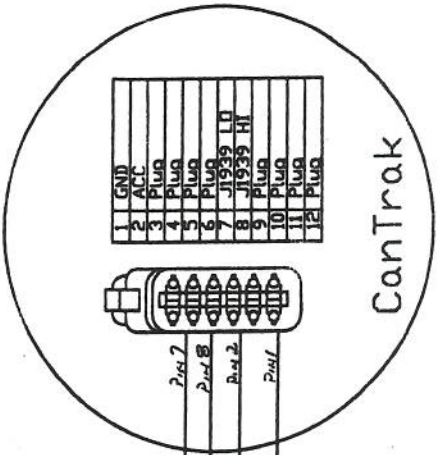
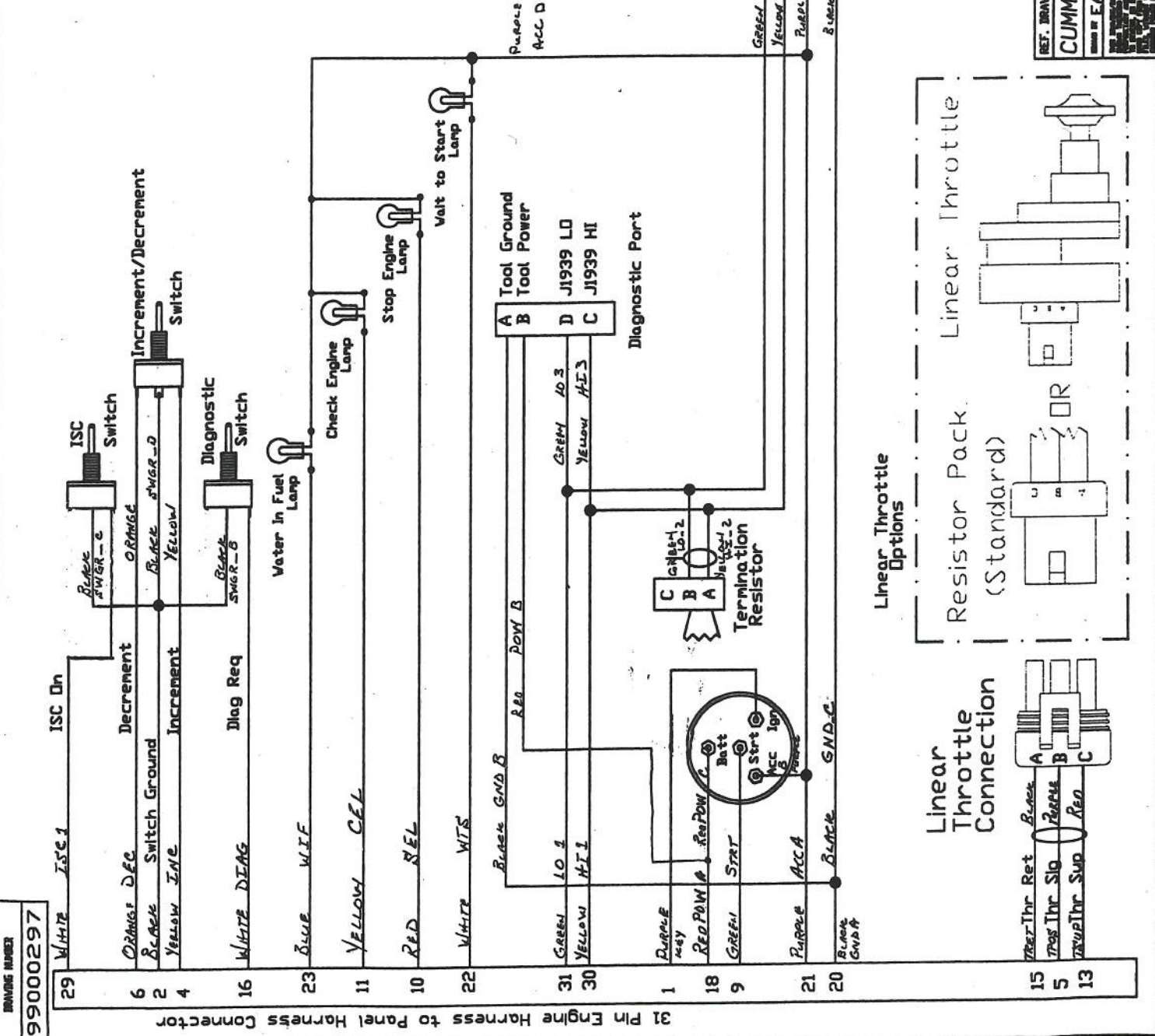

RET. DRAWING STANDARDS: ANSI Y14.5M, ISO 8100
ALL DIMENSIONS INCH

CUMMINS POWER PRODUCTS New Hudson, MI

DATE: 1/24/07

SHEET 1 OF 1

SCALE: N/A

99000297

2007 CUMMINS ELECTRONIC ENGINE
KEY SWITCH

7/3/08
Revision 1

JOHN DEERE CAB KEY SWITCH

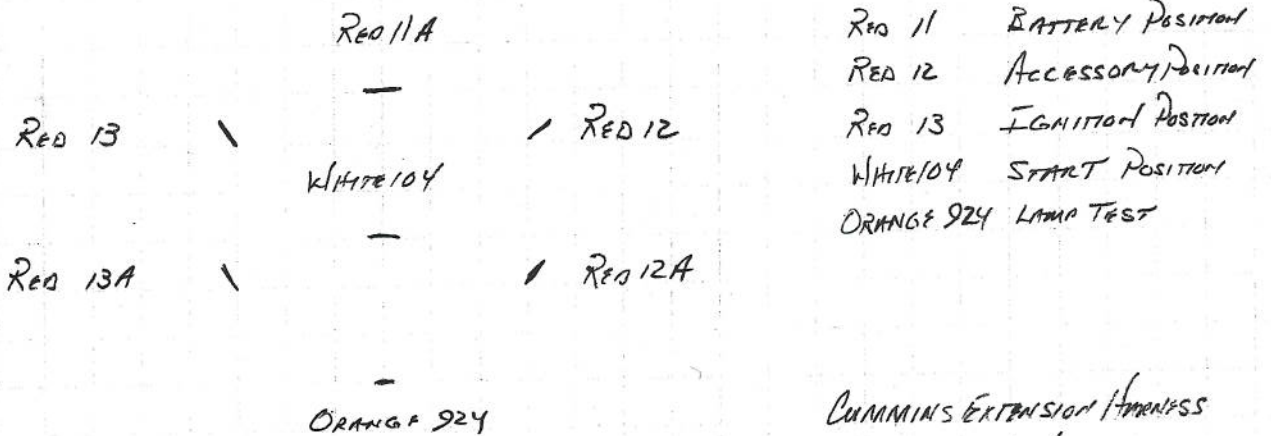

- Red 11 BATTERY POSITION
- Red 12 ACCESSORY POSITION
- Red 13 IGNITION POSITION
- White 104 START POSITION
- Orange 924 LAMP TEST

CUMMINS EXTENSION HARNESS
90060140 12 FT HARNESS

CUMMINS DISPLAY KEY SWITCH

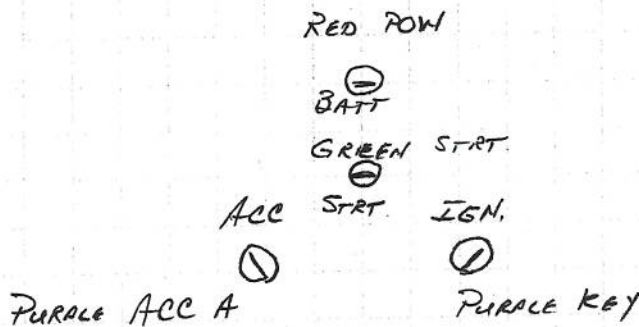

- RED - POW. - 12VDC - BATTERY - TO PANEL CBB (Red 022-12(3)) (P) 11 FT
- PURPLE - ACC A - ACCESSORY - TO CBB IN PANEL (Purple 012-3(3)) (P) 11 FT
- PURPLE - KEY - IGNITION - TO ST 95 IGNITION TERMINAL W/Red 13 (Purple 013) 9(3) (P) 11 FT
- GREEN - STRT - START - TO PANEL START RELAY TERM. B7 (Green 422-13(3)) (P) 11 FT

PH POCLAIN HYDRAULICS

CUMMINS ELECTRONIC CONTROL PANEL.

Run

○

INC

○

ON

○

Idle

BLACK
SWGR-B

WHITE
ISC

DEC
ORANGE
DEC

BLACK
SWGR-D

YELLOW
INC

OFF

DIAG

BLACK
SWGR-C

WHITE
DIAG

Part numbers, 9007, 9008, 9013

LED DIGITAL TEMPERATURE GAUGE

with high temperature recall.

NORDSKOG PERFORMANCE PRODUCTS

1120 YARNELL PLACE

OXNARD, CA 93033

TECHNICAL QUESTIONS 805-483-2411

MONDAY THROUGH FRIDAY 8AM TO 5PM PST

The purple/dimmer wire will cut the brightness by 50% when the wire receives +12 volts. If this wire is connected to the headlights, this will serve as the dimmer. This feature was added so the gauges will not be distracting at night. If you do not want this feature, then you should connect the purple wire to ground for max brightness.

Do not use Teflon tape on the sending unit, because the sending unit housing needs to be grounded to operate properly.

Push the button momentarily to recall high temp reading.

Hold the button for 6 seconds to erase the high reading, if desired.

For the most accurate reading, connect the gauge ground wire directly to the engine block, to ensure that there is a good ground between the sender and the gauge.

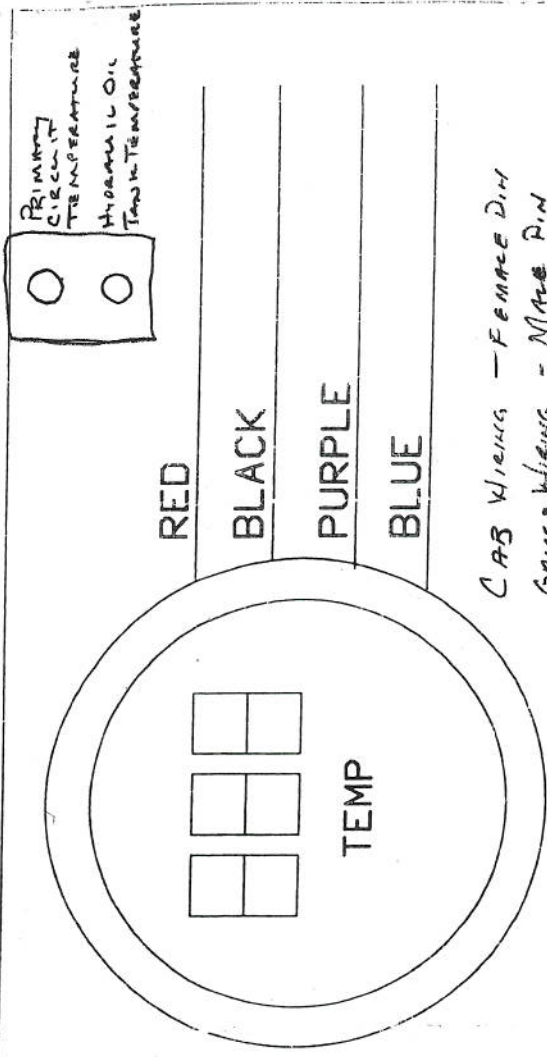

CAS Wires - FEMALE DIN
Gauge Wires - MALE DIN

RED - +12 VOLTS ← RED 21A 12VDC
 PRIMARY HYD. OIL TANK

BLACK - GROUND GREEN 437 ± YELLOW 753 ±
 1 (GND)

PURPLE - DIMMER/+ 12 VOLTS TO DIMMER
 connect to headlights to activate

BLUE - TO TEMP SENDER

- PRIMARY HYD. OIL TANK
- GREEN 425 36 (2)
 - PRIMARY GAUGE
 - PIN 1 RED 21 (RED)
 - 2 BLACK 20 (PURPLE)
 - 3 GREEN 425 (BLUE)
 - 4 GREEN 437 (BLACK)
- YELLOW 752 4 (2)
- HYDRAULIC OIL TANK GAUGE
- PIN 1 RED 21 (RED)
 - 2 BLACK 20 (PURPLE)
 - 3 YELLOW 752 (BLUE)
 - 4 YELLOW 753 (BLACK)

Co:	NORDSKOG PERFORMANCE PRODUCTS
Title:	TEMP GAUGE WIRING
Board:	
Author:	
Date:	
Revision:	A
Size:	A

REVISIONS				
ZONE	REV	DESCRIPTION	DATE	APPROVED

Note:
 1-Cyber-Tech, Inc. Proposed Handy-Grip® wiring to be APPROVED by the customer prior to manufacture and installation for operator use.

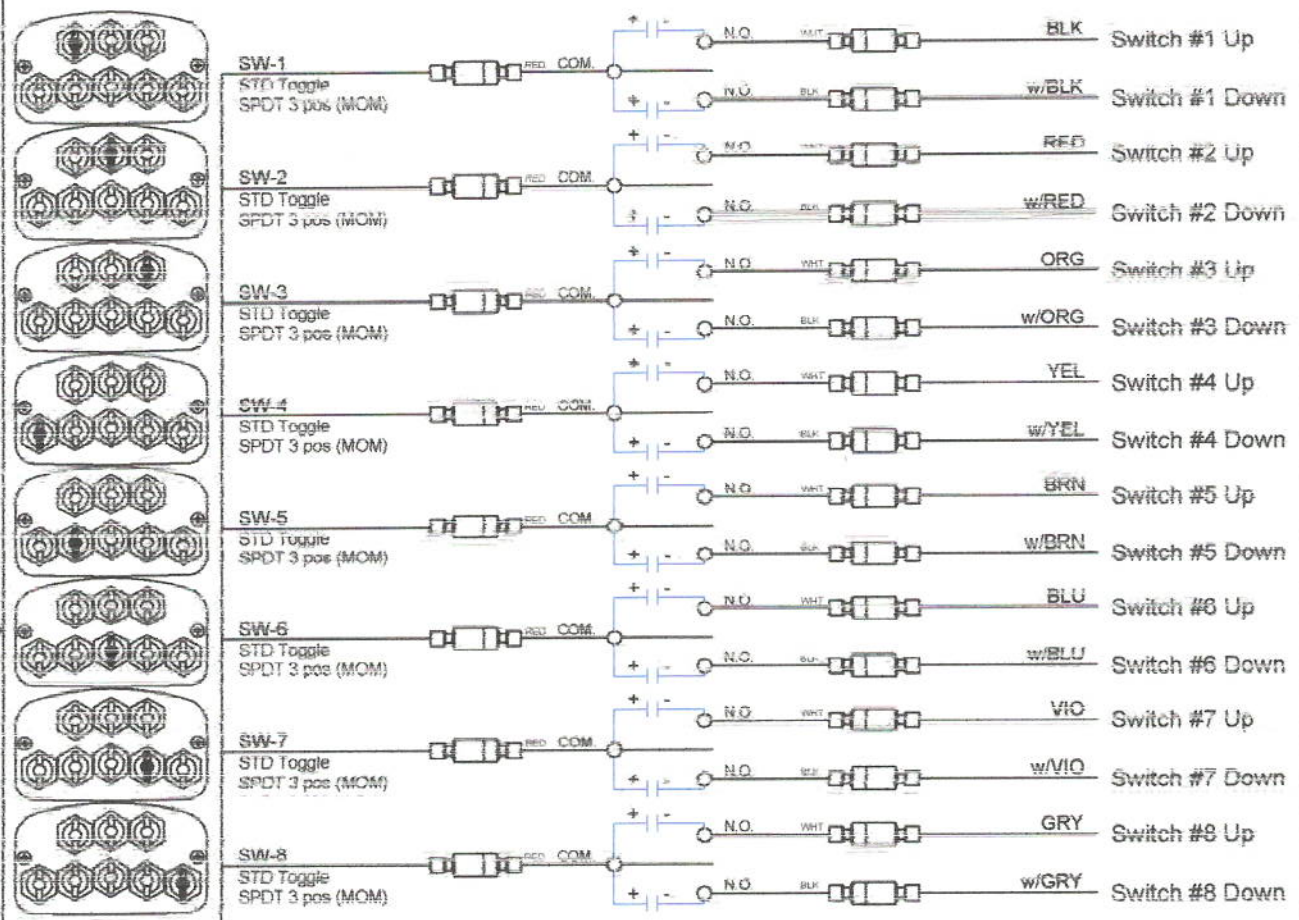

CAUTION:
 Metal Handle MUST Be Grounded For Safe Operation!

GRN Ground -
 WHT Common +
 (30 vDC 5amp Max)

Cyber-Tech, Inc. P.O Box 23801 Portland, Or 97281-3801 1.800.621.8754 www.cyber-tech.net	8601-RB Handy-Grip (8Tog w/Boots)		
	SCHEMATIC DIAGRAM		
SIZE	FSCM NO.	DWG NO.	REV
	503-620-8580	CTI-2022291	
SCALE	1:1	D DOWERS	SHEET 1 OF 1

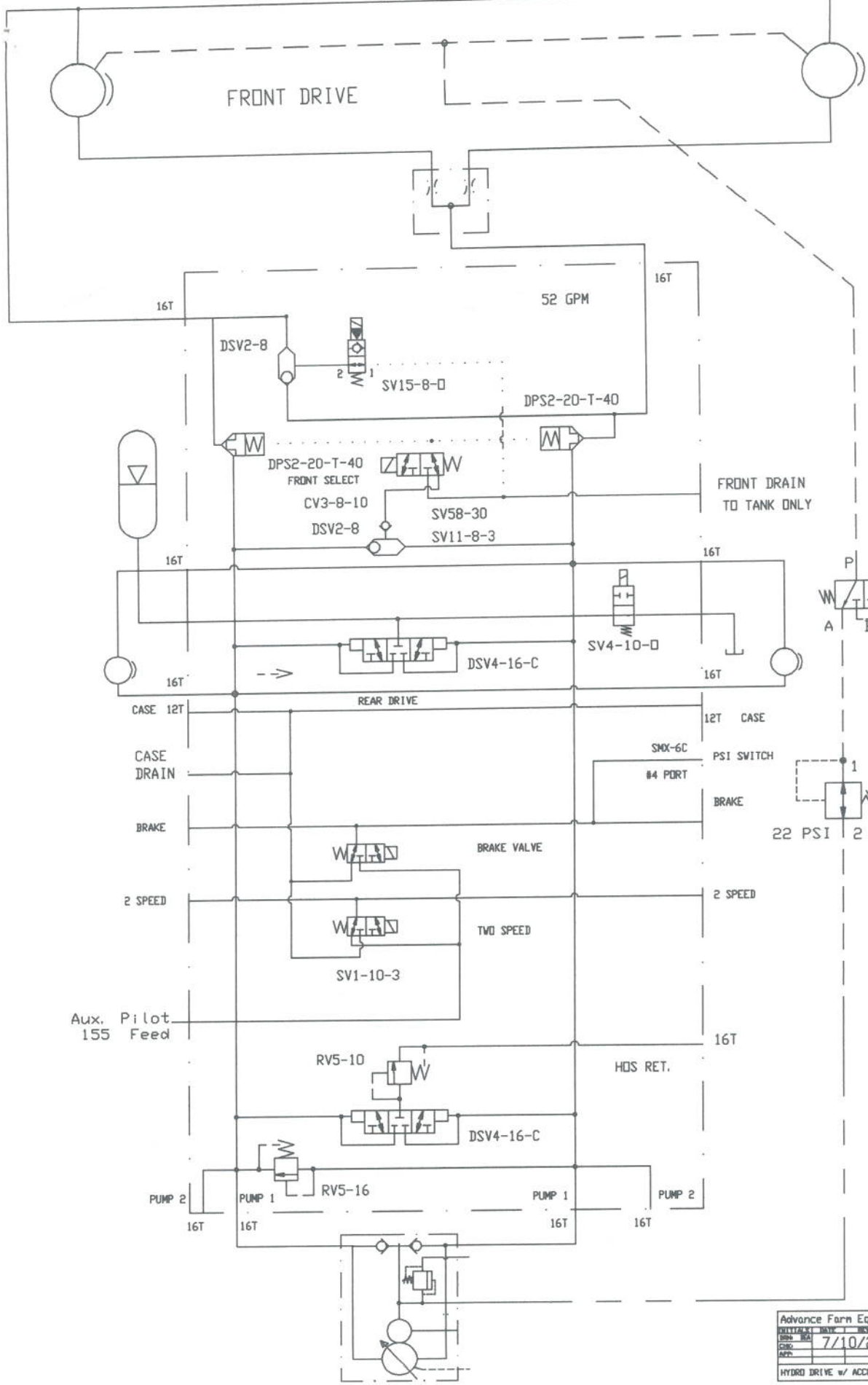

Advance Farm Equipment			
DATE	BY	REVISION	NO.
7/10/2009			
APP.			
HYDRO DRIVE w/ ACCUMULATOR PIS-0150-C			

7/13/09
 409037
 HJV
 YRSPH65LAH

7/13/09 Revision - A00514-10.0

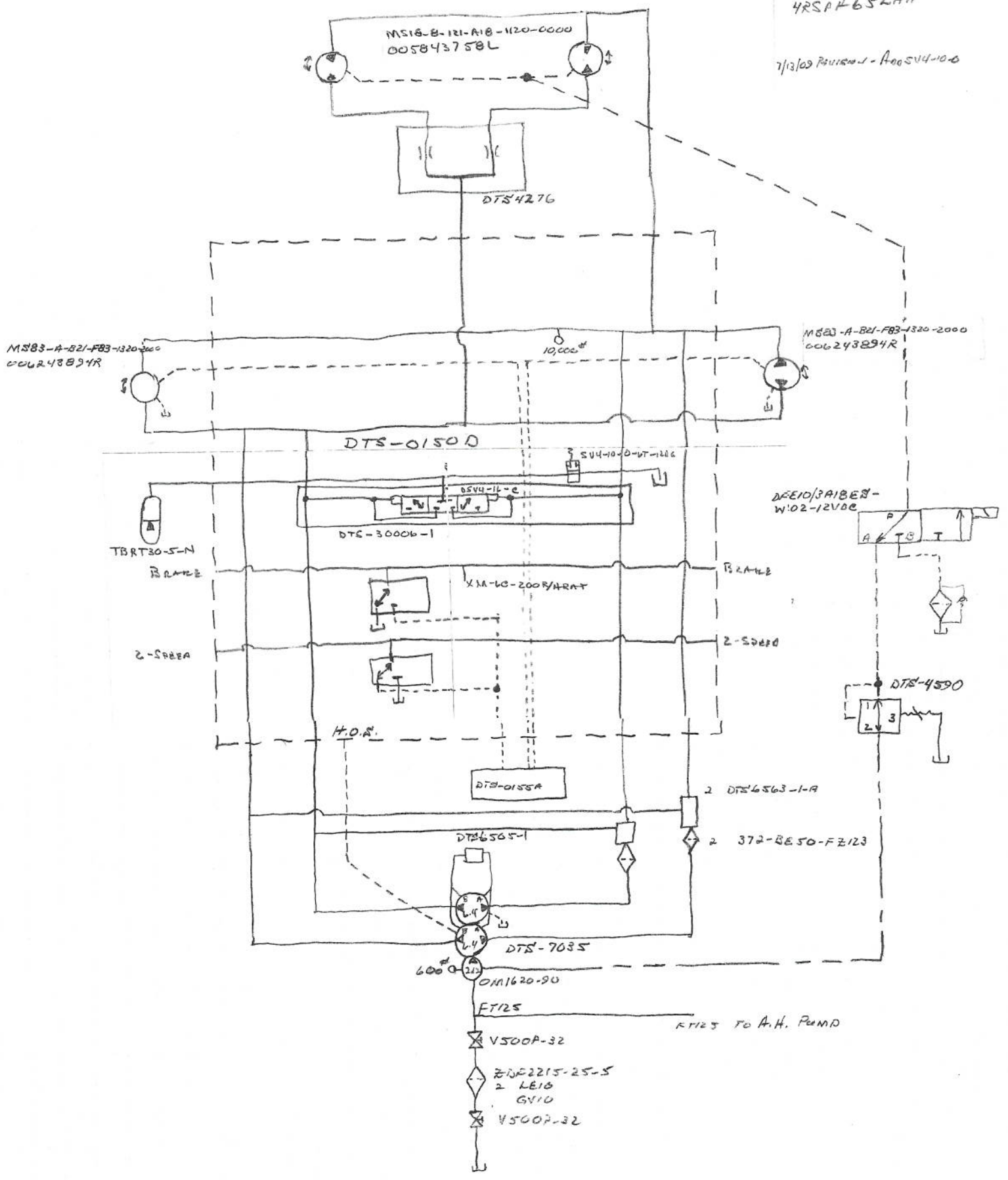

5/4/09
#09037
1FJV
4RSPH65LAAH

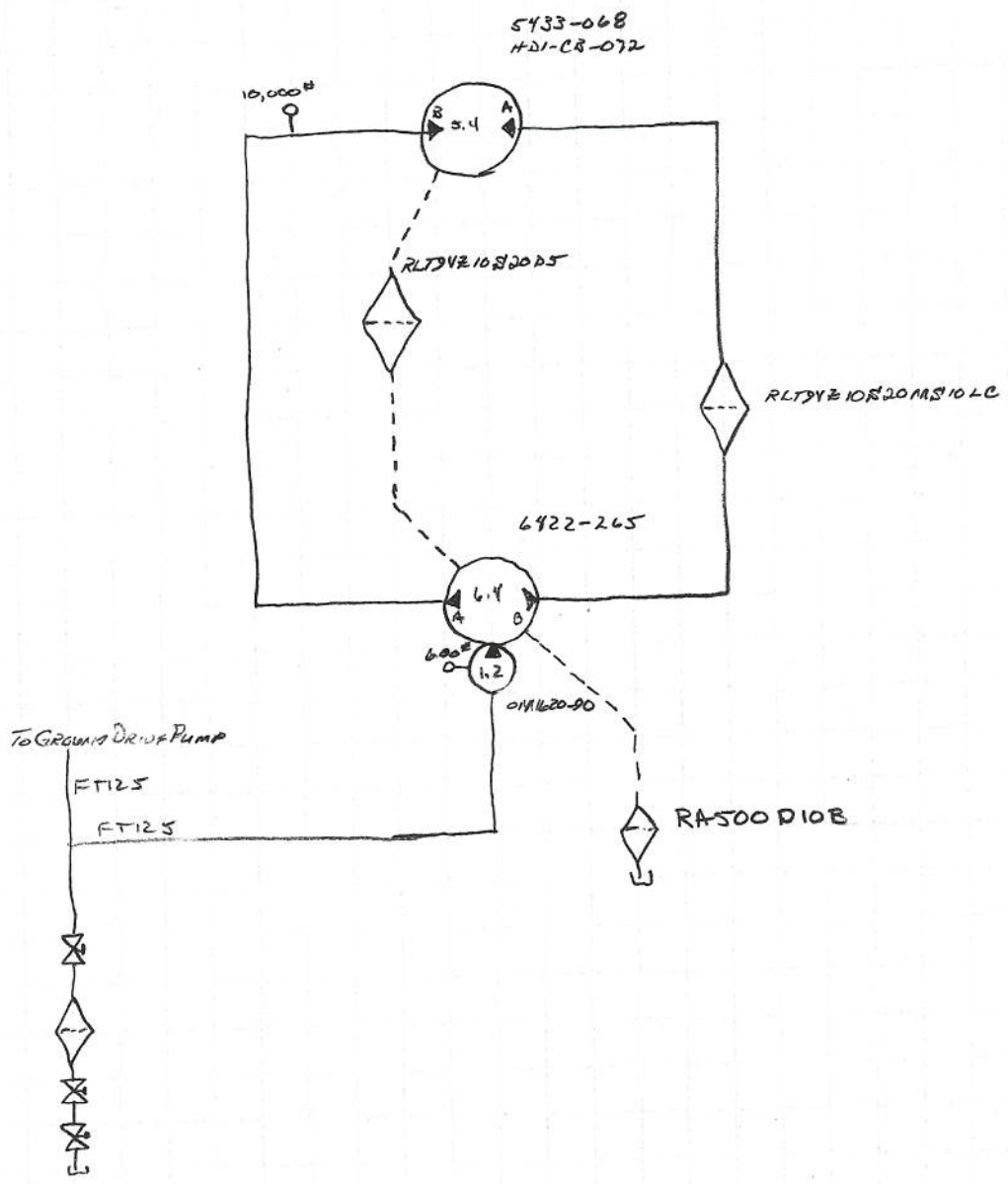

5/9/09
#09037
HJV
YRSR#65LAAH

LEFT PRIMARY
112-105B
28-006-5162

DTS-8811

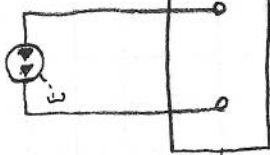

RIGHT PRIMARY
112-105B
28-006-5162

DTS-8811

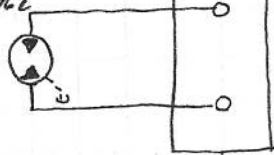

DTS-7005-2

RLTSV210F20DS

DTS-7005-2

RV5-10-8-0-3
600#

5000#

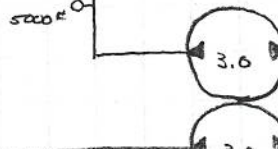

DTS-2809

0M1620-90

RAS00 D 10B

FT15 To V10
FT100 PUMP

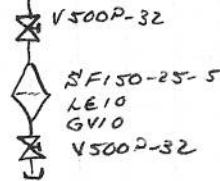

5/4/09
E09037
HJV
4RSPH 65LAN

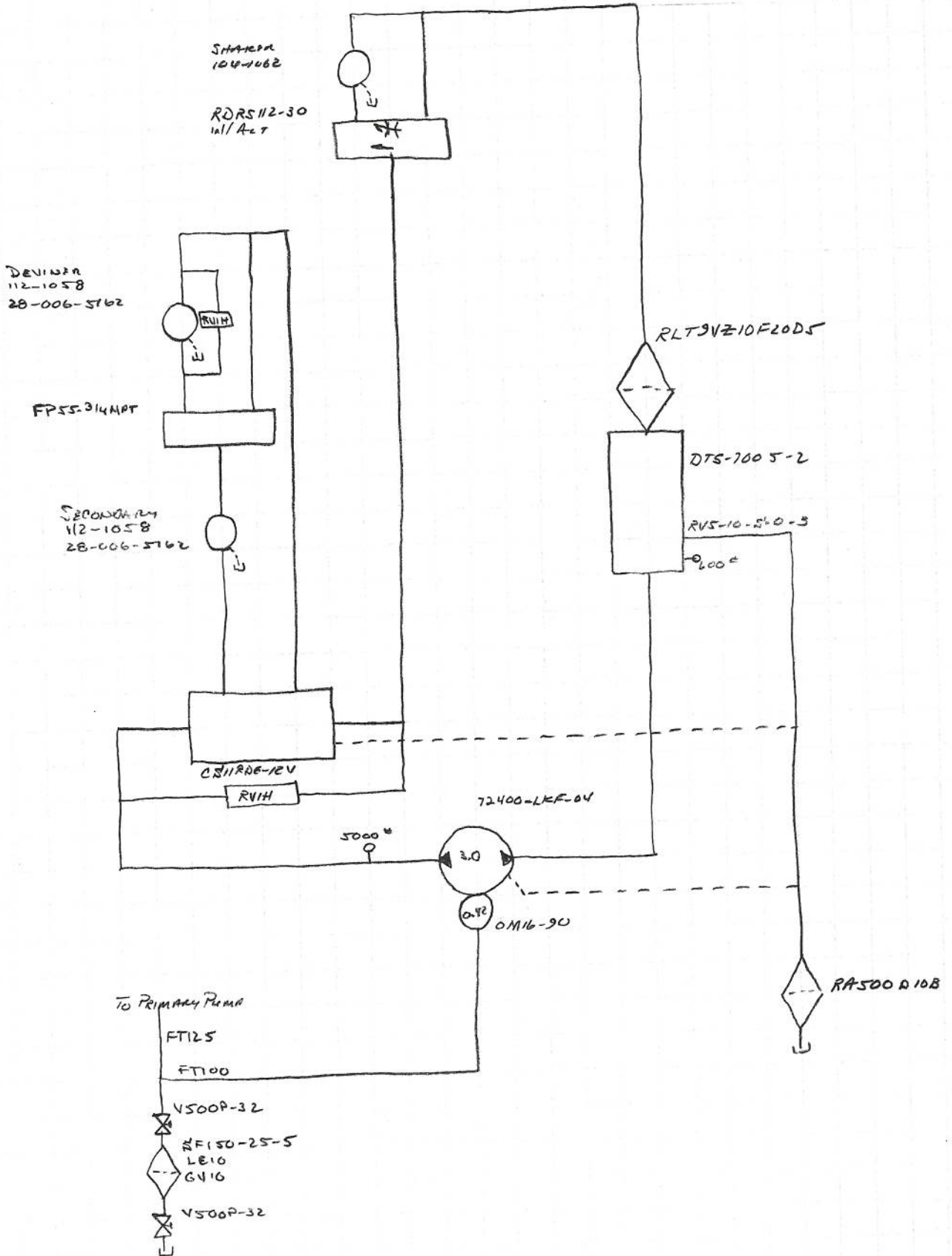

5/4/09
 #09037
 HTV
 HRSF#65(LAH)

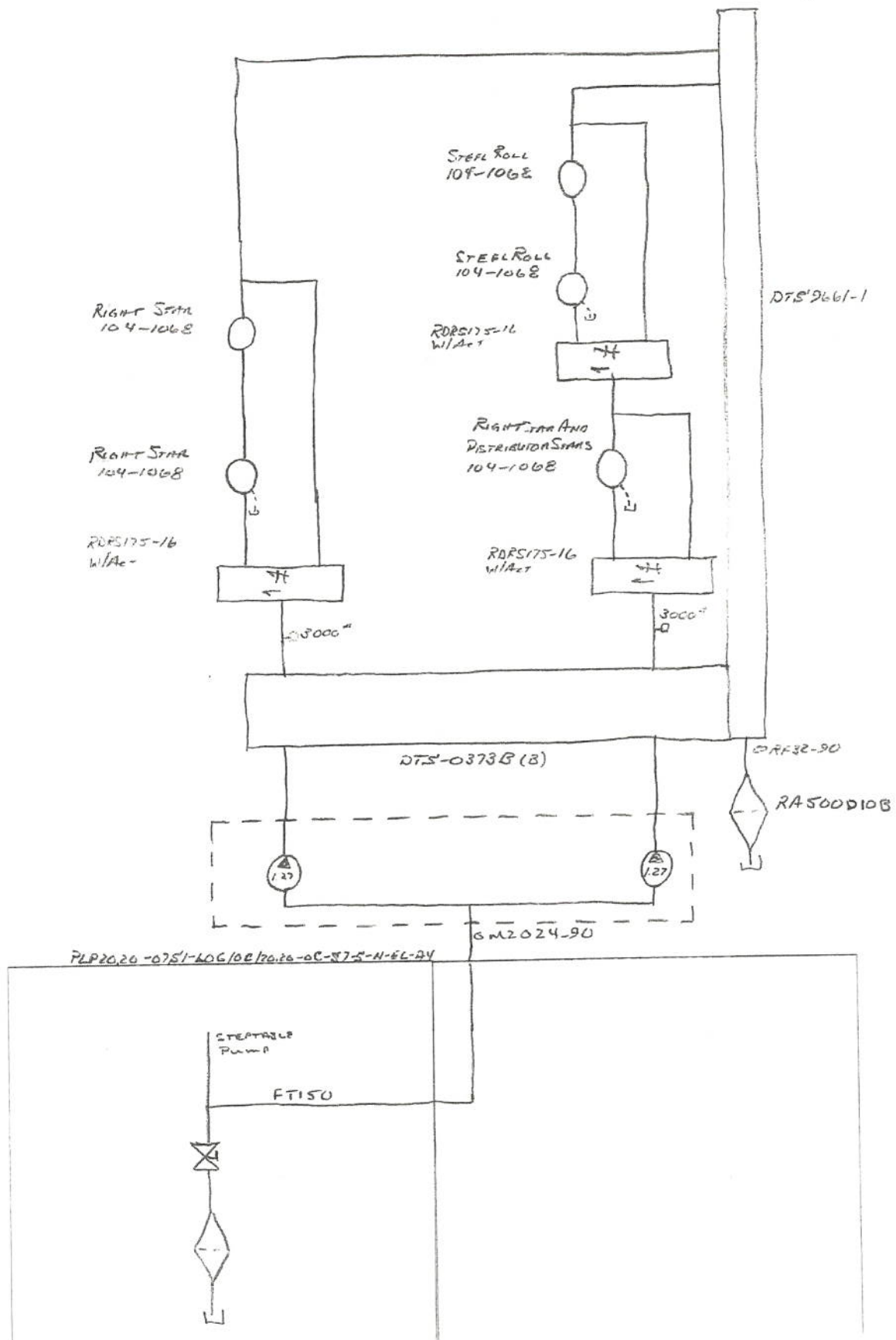

5/4/09
 #09037
 HJV
 4RSPH6SLAH

CROSS DISTRIBUTION STATION
 ROLLS
 104-1067

SIDE RETURN
 104-1067

RDRS112-30
 W/ACT

STONE
 104-1067

SIDE
 104-1067

RDRS112-30
 W/ACT

ORF32-90
 HC180-0120-
 BP60

ORF32-90

ORF32-90

RA500 D105

DTS-9661-1

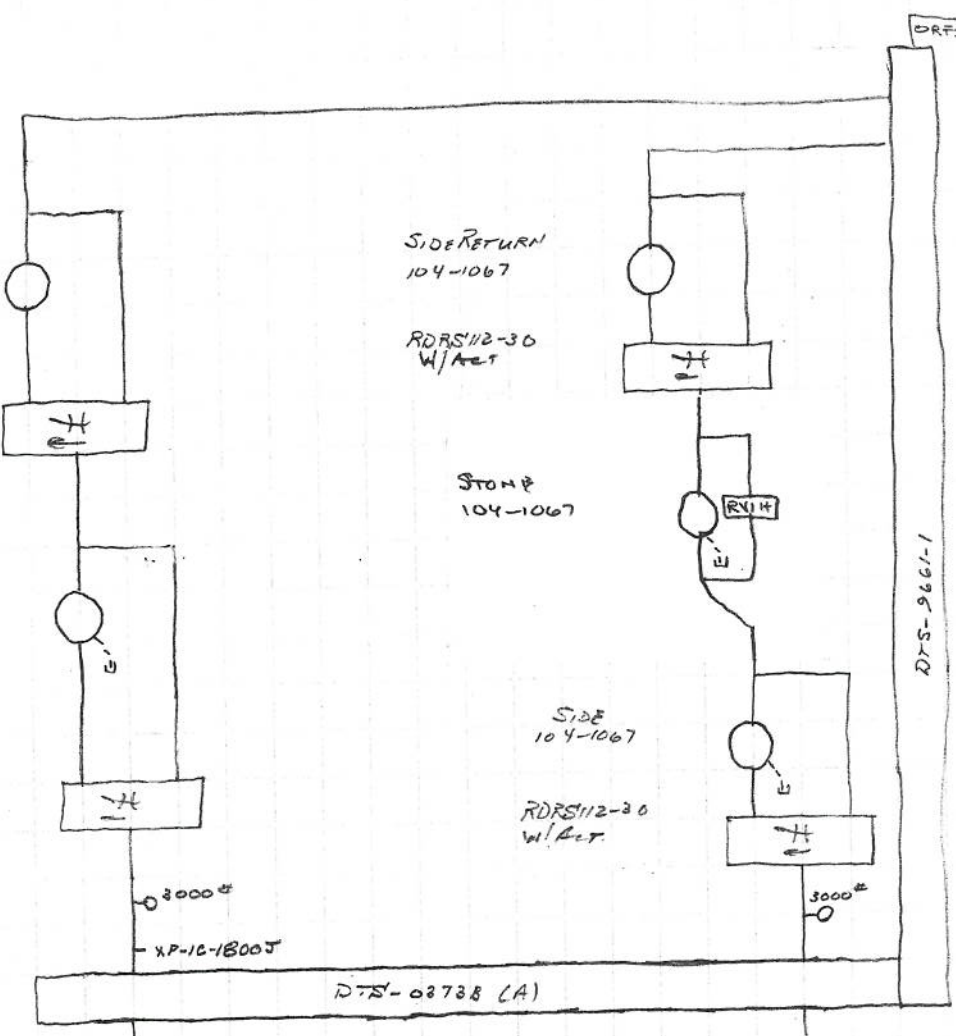

3000#
 XP-16-1800J

3000#

DTS-03738 (A)

FDO6181800

35VQTB/S
 02-125554-5
 20029-009

ORF4048-30

FT250

J8VL-20-408

TF2540-3

4.13



5/4/09
 409037
 HJV
 4RSPH65LPH

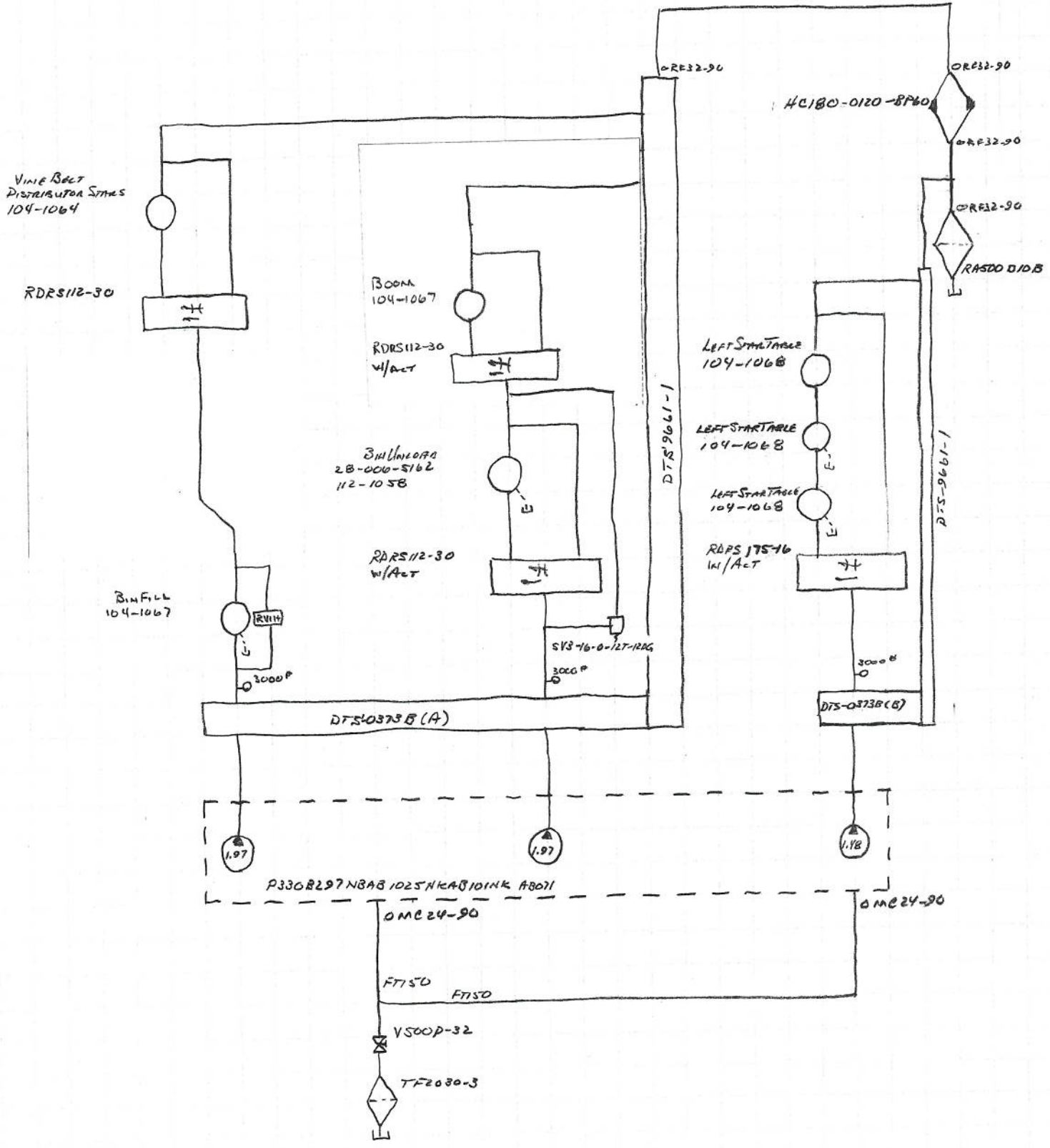

5/4/09
#09087
1/5/11
HRSAN65LAAH

GAINMER STEPTABLE

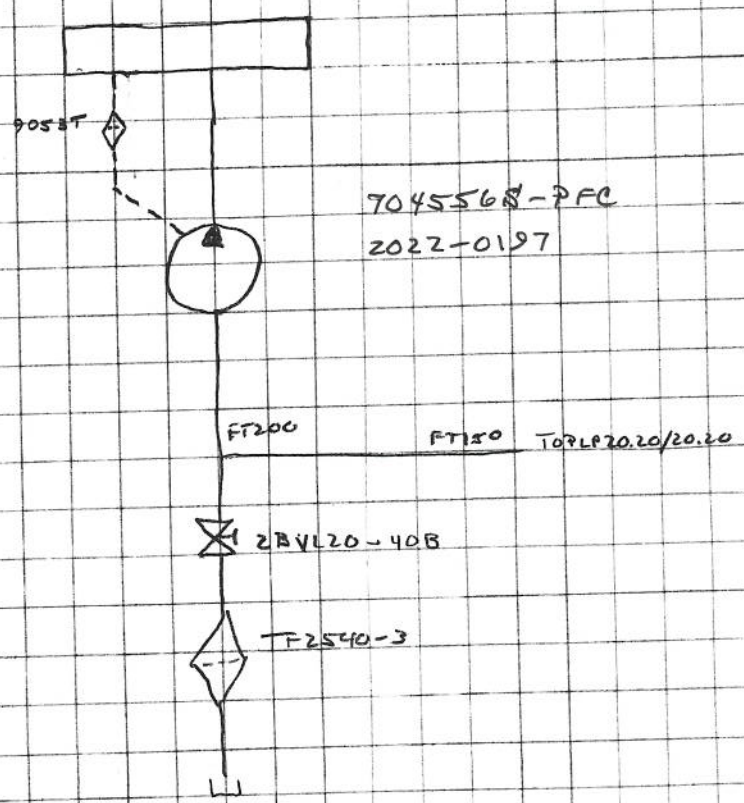

5/4/09
#09037
HJV
4RSPH65LPH

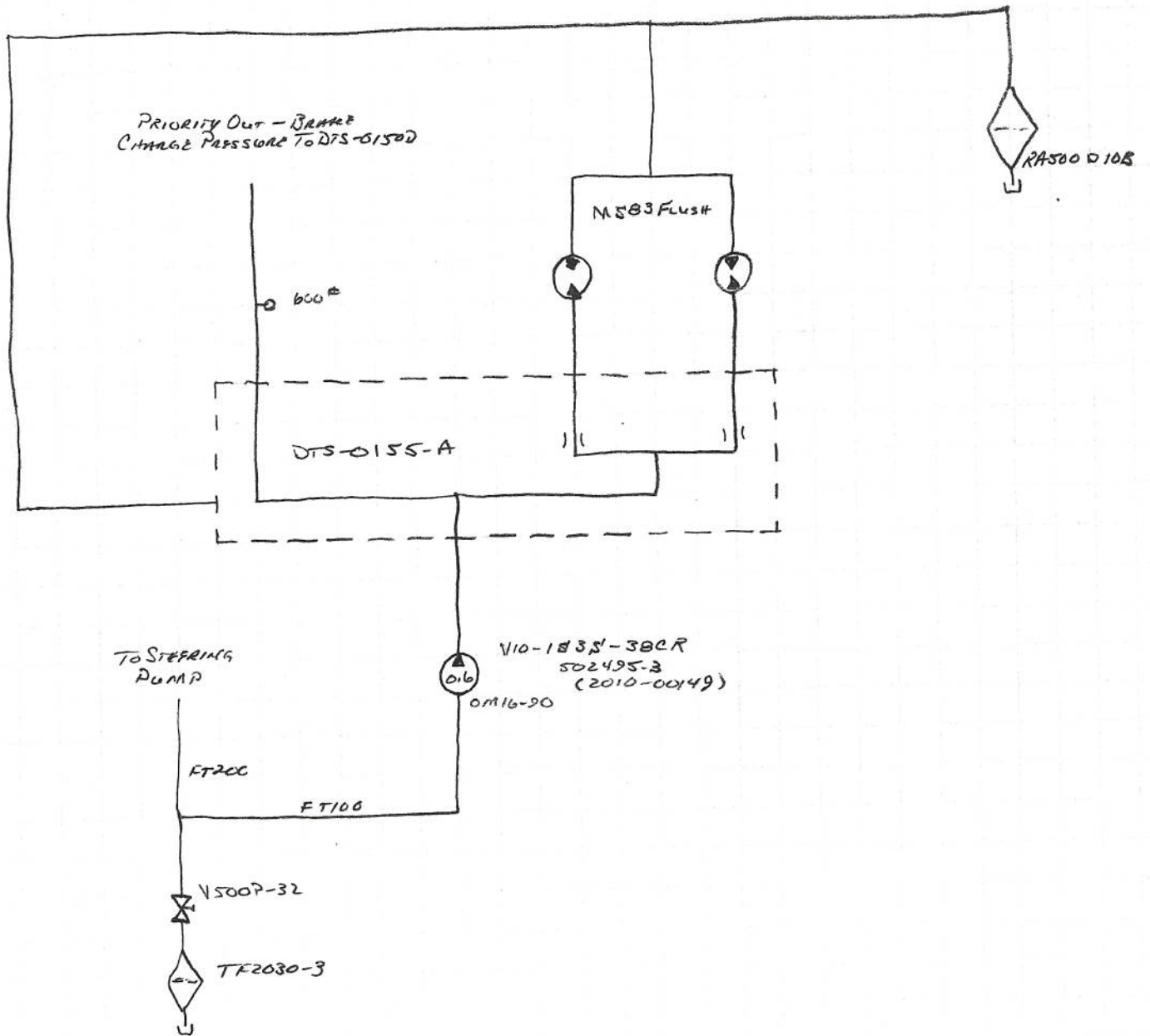

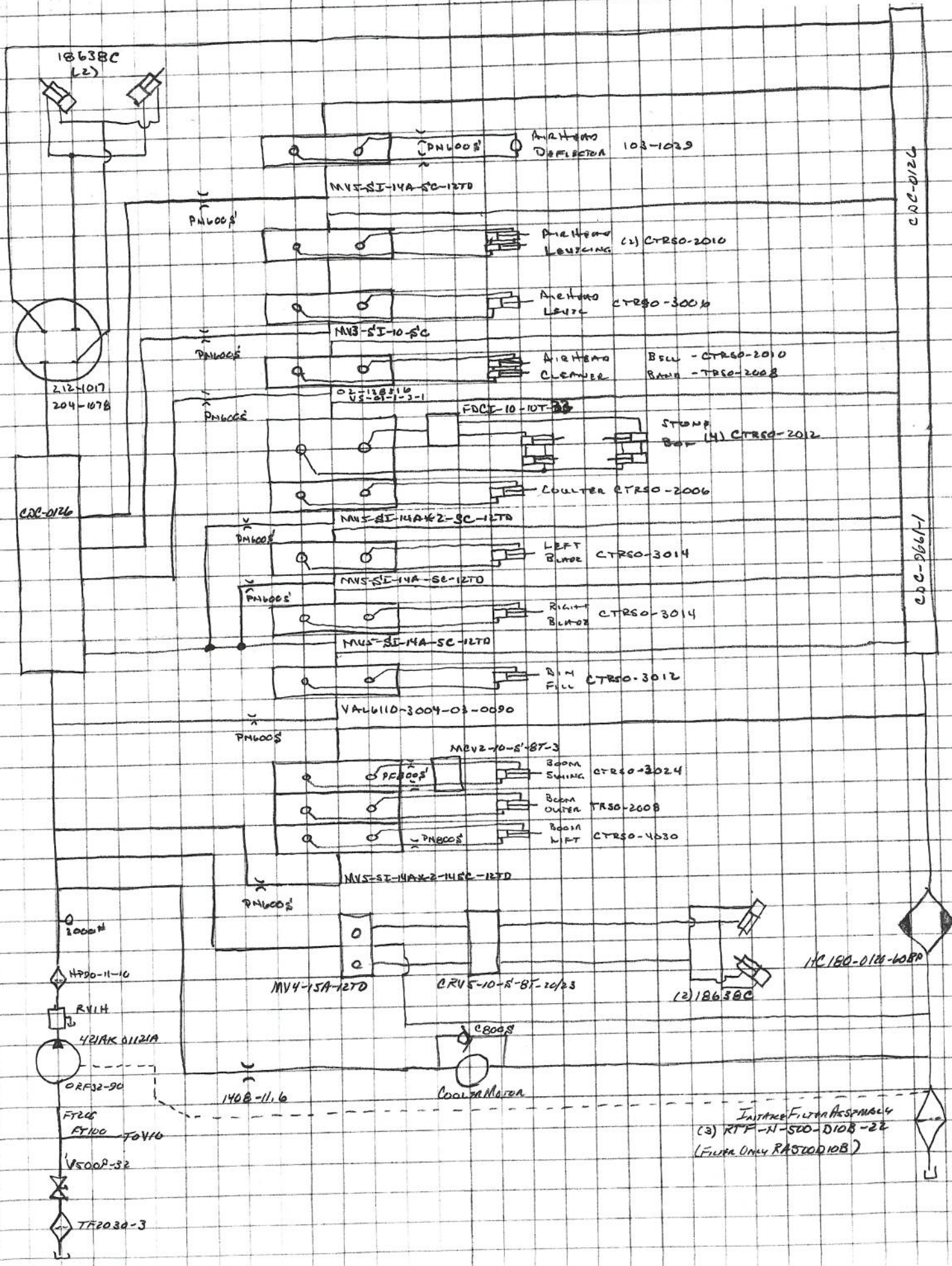

CDC-0126

CDC-0126

CDC-0661-1

HC180-0120-608P

INSTANT FILTER ASSEMBLY
(3) RTF-N-500-D108-22
(FILTER ONLY RAS1010B)

1863BC
(L2)

PN600S

Air Head
DIFFLECTOR

103-1029

MV5-SI-14A-5C-12TD

PN600S

Air Head
Leaking

(2) CTR50-2010

MV3-SI-10-5C

PN600S

Air Head
LEVEL

CTR50-3006

02-118216
VS-SI-1-3-1

PN600S

Air Head
CLEANER

BELL - CTR50-2010
RAIN - TR50-2008

FDC1-10-10T-23

STAMP
BOT (4) CTR50-2012

COOLER CTR50-2006

MV5-SI-14A-2-5C-12TD

PN600S

LEFT
BLADE

CTR50-3014

MV5-SI-14A-5C-12TD

PN600S

RIGHT
BLADE

CTR50-3014

MV5-SI-14A-5C-12TD

RIM
FILL

CTR50-3012

VAL6110-3004-03-0090

PN600S

MV2-10-5-8T-3

BOOM
SWING

CTR50-3024

BOOM
OUTER

TR50-2008

BOOM
LEFT

CTR50-4030

MV5-SI-14A-2-145C-12TD

PN600S

MV4-15A-12TD

CRV5-10-5-8T-20/23

C804S

COOLANT MOTOR

(2) 1863BC

140B-11.6

H790-11-10

RV1H

421AK 01121A

ORF32-90

F200
FY100
F0410

VS00P-32

TF2030-3

4"

TF2540-3
2 1/2" 90° STEEL
2 1/2" CLS N/A
2 BVL 20-40B
FT250
* 35VQTB'S

3 1/2"

3" X 2" BUSH
2" CLS N/A
V500P-32
FT200
2" 90° STEEL
WU3-32AK-2"
ZDFR215-25-5
WU3-32AK-2"
2" 90° STEEL
2" CLS N/A
V500P-32
2" CLS N/A
2" TEE

X 2" X 1 1/4" BUSH
FT25
2" X 1 1/4" BUSH
FT25
* 7/8" X 6.4
* 6.4

3"

TF2030-3
2" 90° STEEL
2" CLS N/A
V500P-32
2" CLS N/A
2" TEE

X FT200
* 421AK
O 2" 90° STEEL
2" X 1" BUSH
FT100

* V10

3"

TF2030-3
2" 90° STEEL
2" CLS N/A
V500P-32
2" CLS N/A
2" TEE

X 2" X 1 1/2" BUSH
FT150
* TRIP P330
O 2" 90° STEEL
2" X 1 1/2" BUSH
FT150

* TRIP P330

3"

3" X 2" BUSH
2" 90° STEEL
2" CLS N/A
V500P-32
2" X 1 1/2" BUSH
SF150-25-5
1 1/2" CLS N/A
2" X 1 1/2" BUSH
V500P-32
2" CLS N/A
2" TEE
X 2" X 1 1/4" BUSH
FY125
* TAN. 3.0/3.0
O 2" 90° STEEL
2" X 1 1/4" BUSH
FY100
* SINGLE 3.0

4"

TF2540-3
2 1/2" 90° STEEL
2 1/2" CLS N/A
2 BVL 20-40B
2 1/2" CLS N/A
2 1/2" TEE
X 2 1/2" X 2" BUSH
FT200
* STEP TABLE DUMP
O 2 1/2" X 2" BUSH
2" 90° STEEL
2" X 1 1/2" BUSH
FT150

* TAN. 20.20/20.20

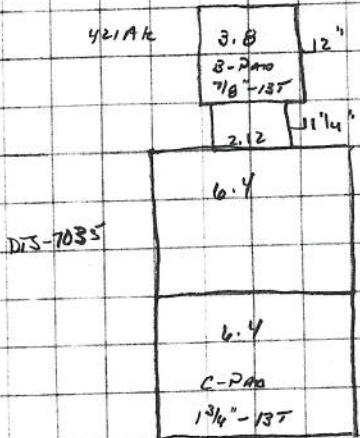

L.R.

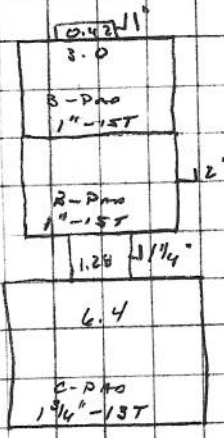

L.L.

L.R. TAN. 6.4
421AK
L.L. 6.4

3.0
T.R. 35VQTB'S

P330

T.L. TAN. 3.0/3.0

TAN. 20.20/20.20

ENGINE - V10

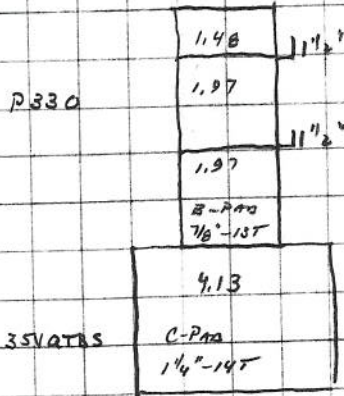

T.R.

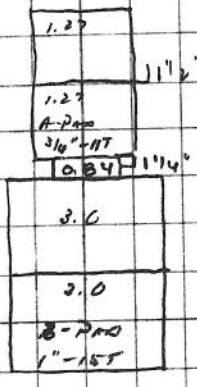

T.L.

TAN. 3.0/3.0

DURST - D13387

4P009-1.20E-N11-RRH-CCH-CEH-CEH-LS'

DRIVE PLATE - TORSION CONTROLS - 19310

V10 0.6 1 1/4" A-PAD 3/16"-13T
ENGINE 450HP
CUMMINS QSX-15

GROUND DRIVE
STEERING
AIR HORN
STEP TABLE
SECONDARY
CROSS
SIDE
BIN FILE
BIN UNLOADER
LEFT STARTABLE
LEFT PRIMARY
RIGHT STARTABLE
RIGHT STARTABLE
RIGHT STARTABLE ST.
BRAIN PRESSURE
FLUSHING.

5/4/09
#09837
HJV
4RSPH65LAAH

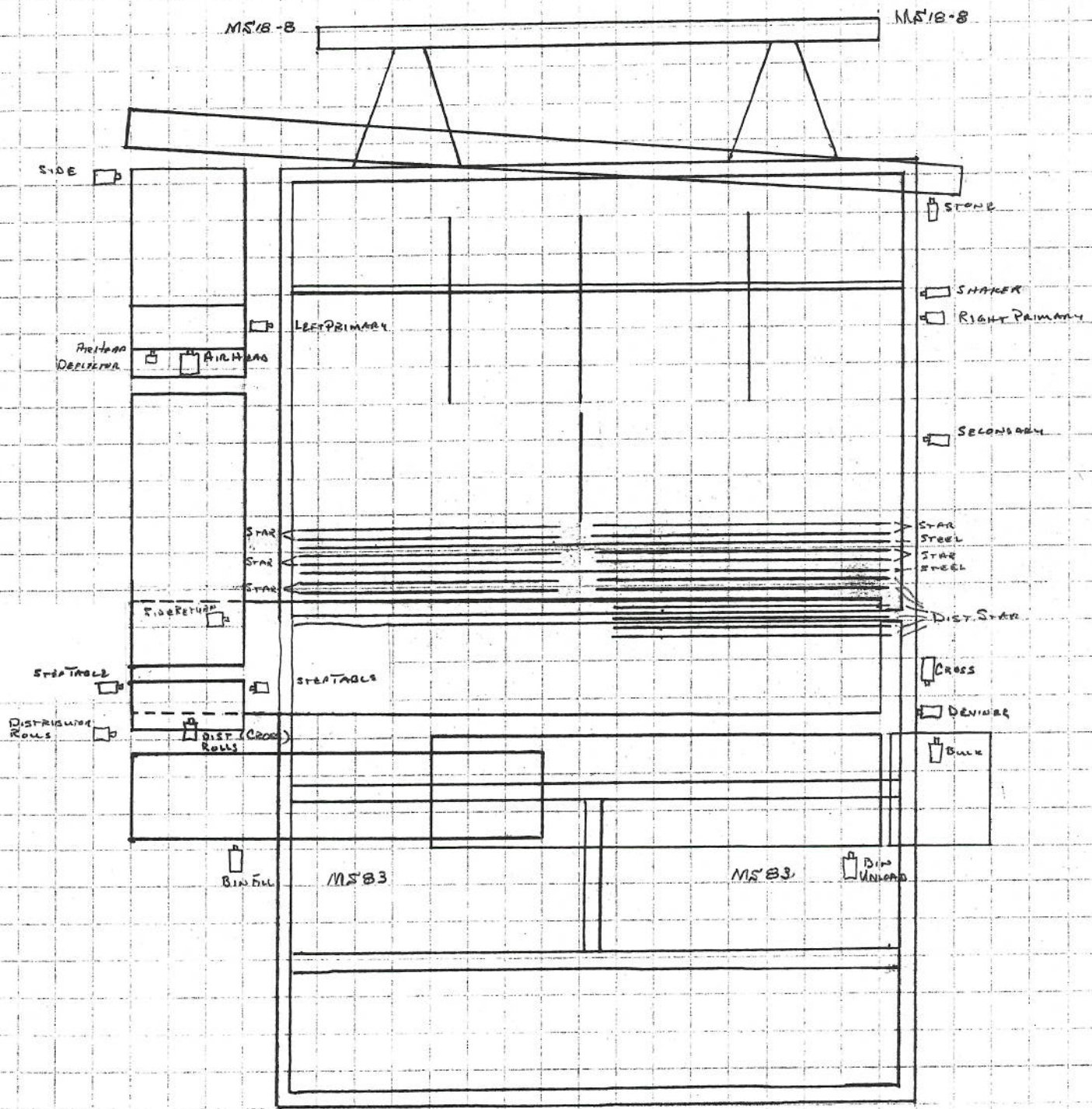

5/9/09
 #09037
 HJV
 4RSPH65LAH

MS 18-B MS 18-B

Side
 104-1067
 RDRS W/ACT

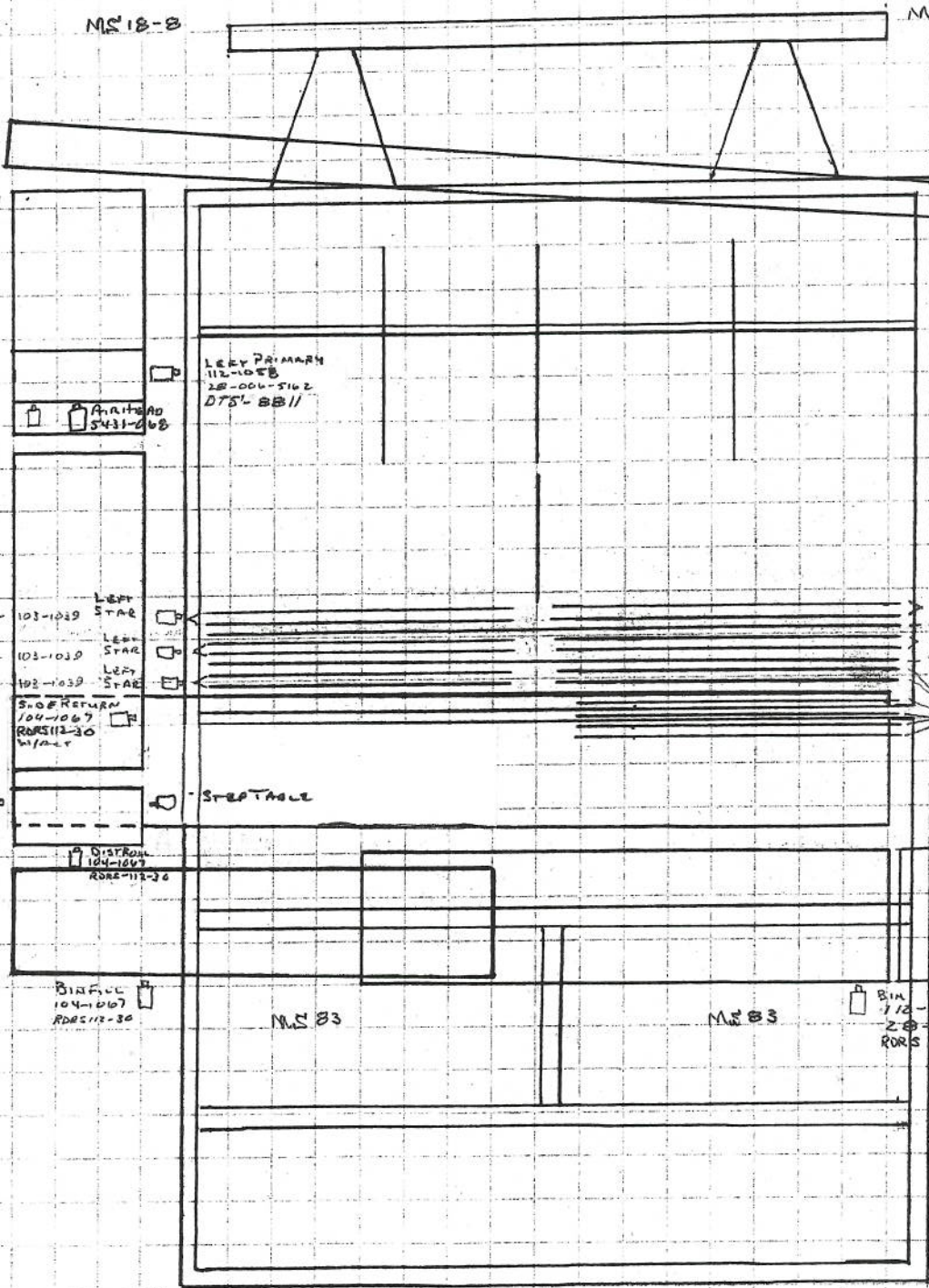

STONE
 104-1067

SHALLOR
 112-105B
 RDRS 112-30
 W/ACT
 RIGHT PRIMARY
 112-105B
 2B-006-5162
 DTSL BB11

SECONDARY
 112-105B
 2B-006-5162
 OS 11RBE-12V

RIGHT STAR 103-1039
 STEEL 103-1039
 STAR 103-1039
 STEEL 104-1067

DIST. STAL 104-1067 RDRS W/ACT

CROSS RDRS 112-30
 104-1067 W/ACT

DENING
 112-105B
 2B-006-5162
 RPS-31/NPT

BULK
 104-1067
 RDRS 2-00
 W/ACT

BIN UNLOAD
 112-105B
 2B-006-5162
 RDRS W/ACT

RDRS 175-16
 W/ACT

103-1039 LEFT STAR
 103-1039 LEFT STAR
 102-1039 LEFT STAR

S.O.E RETURN
 104-1067
 RDRS 112-30
 W/ACT

STEATH

DIST. ROLL
 104-1067
 RDRS 112-30

BIN FILL
 104-1067
 RDRS 112-30

DIST. ROLL
 104-1067
 RDRS 112-30

STEATH

Airhead
 Deduction
 101-1039

Airhead
 5431-068

LEFT PRIMARY
 112-105B
 2B-006-5162
 DTSL BB11

STEATH

MS 83

MS 83