

H 1016

Alkin-Carozin

4 RSPH ST - Cole. 1991



Fischer-Flack, INC.

6585 N. Jerome
P.O. Box 229
Alma, MI 48801
517/463-6104
FAX 517/463-1967

119 W. Fletcher
Alpena, MI 49707
517/356-3411
FAX 517/356-1138

303 W. Water St.
Flint, MI 48502
313/235-6420
FAX 313/235-8904

CORPORATE HEADQUARTERS
2115 RUST AVENUE • P.O. BOX 1508
SAGINAW, MICHIGAN 48605 • 517/752-4181

3201 Bay City Rd.
P.O. Box 1687
Midland, MI 48640
517/496-3600
FAX 517/496-3044

2415 24th St.
Port Huron, MI 48060
313/985-8183
FAX 313/985-8183 Ext. 22

MICHIGAN WATTS 1-800-968-4181 • FAX 517-752-0538

#1016

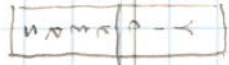
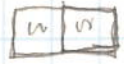
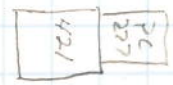
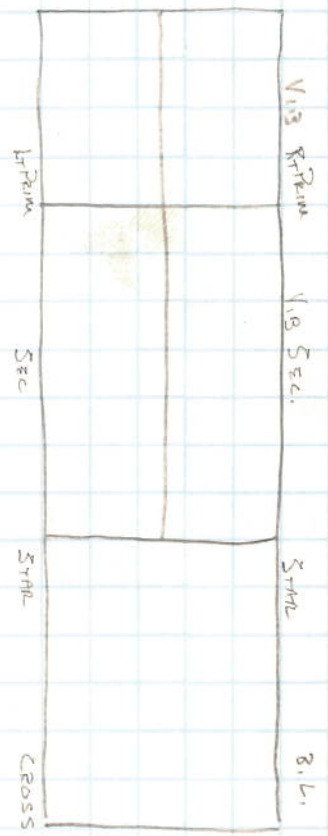
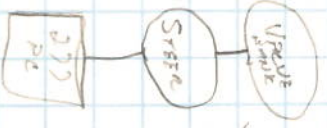
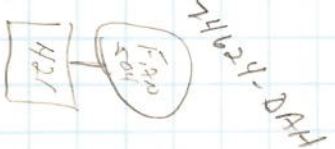
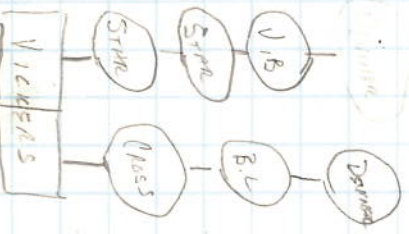
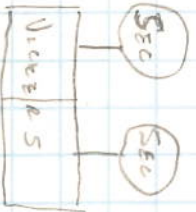
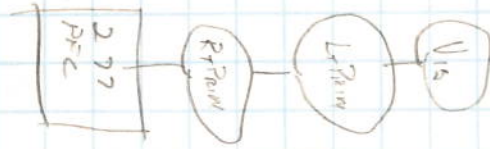

ABRASIVES / GRINDING-CUTTING FLUIDS / CUTTING TOOLS - MACHINE TOOLS
ELECTRICAL APPARATUS AND SUPPLY / FLUID POWER / INDUSTRIAL RUBBER PRODUCTS / RESIDENTIAL
AND COMMERCIAL LIGHTING / MATERIAL HANDLING / POWER TRANSMISSION

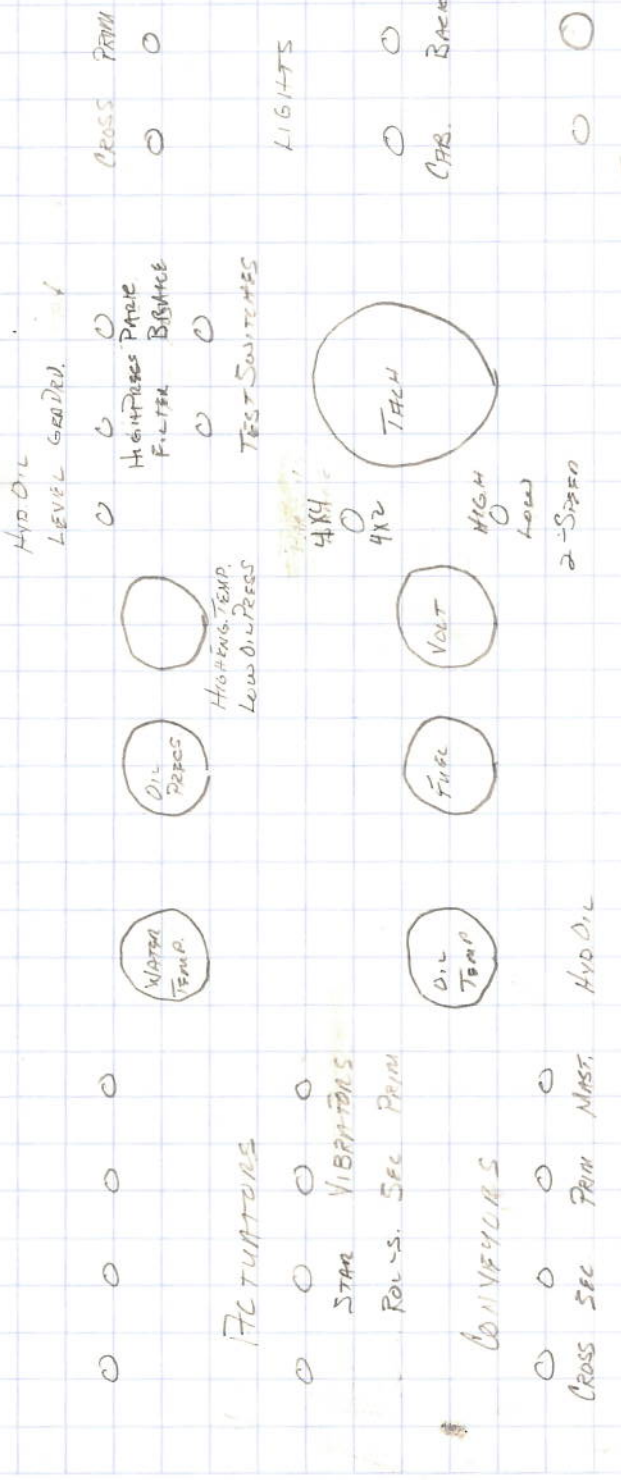

4/14 ADDEND 6/95



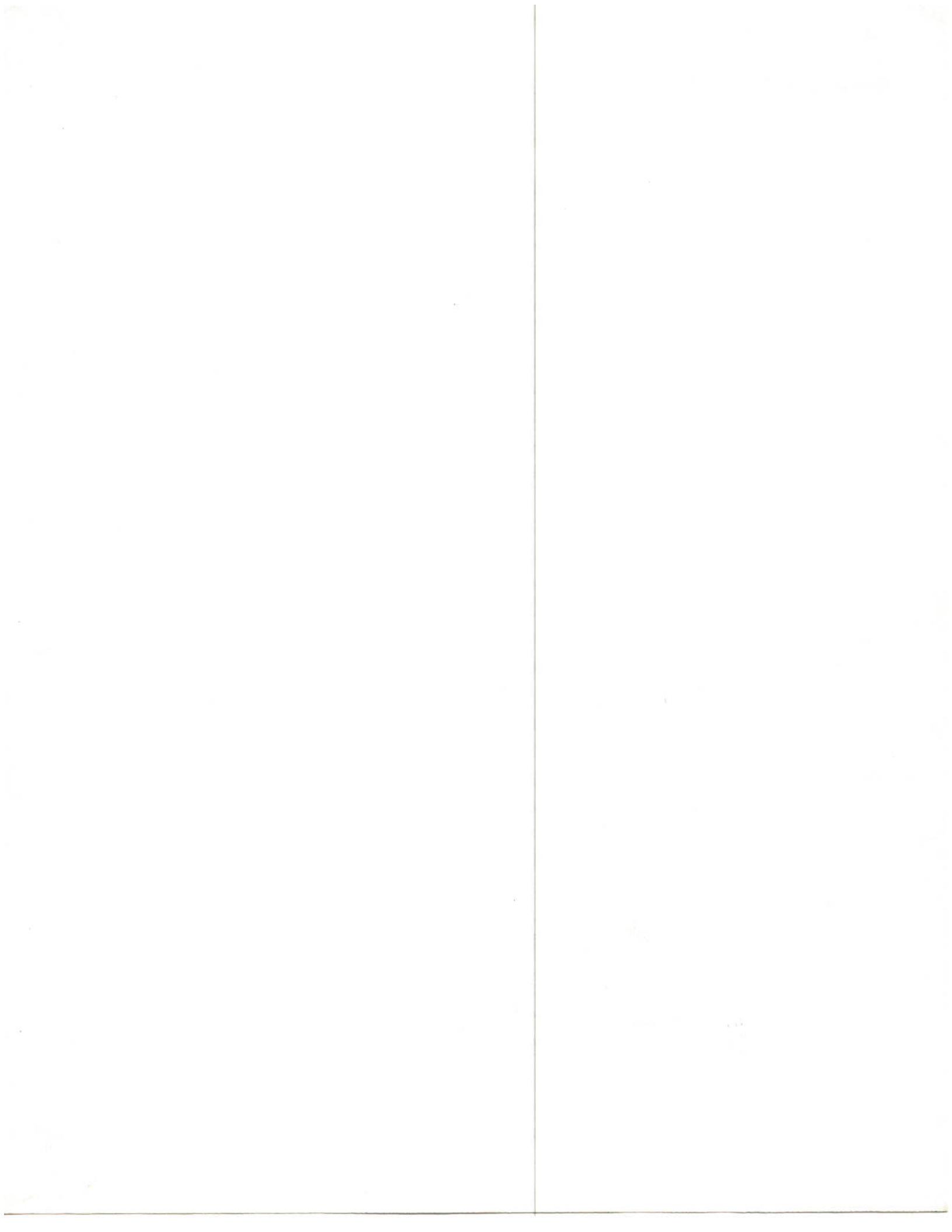





R.P.M. INC.

400 - 36TH STREET, S.E.
GRAND RAPIDS, MICH. 49508

PHONE (616) 247-0633

#1016

BLACK	#1		STAR ROLL ACT
	12	RED	HI-LO SOL.
	17	BLUE	BRAKE & CLUTCH SOL. (PUN FROM #4 TO BACK SIDE OF SWITCH)
	22	ORANGE	STAR ROLL ACT.
RED	#2		STOP SWITCH TO SIDE OF FOOT TO STARTER SOL. #15
	7	BLACK	TACH 'S' TO SENSOR
	18	BLUE	TACH GND. TO SENSOR
	23	ORANGE	HYD OIL TEMP. SENSOR
BLUE	#3		LIGHT TO GND. HYD. FLT. #3
	8	BLACK	#9 FUSE TO #1 ON GND. HYD. FLT.
	13	BROWN	IGN ON SWITCH TO FUEL SHUT OFF SOL.
	24	ORANGE	"C" ON RED FUSE TO A.C. COMPRESSOR
ORANGE	#4		WATER SENDER (STUD)
	9	BLACK	WATER LIGHT (SPARE)
	14	RED	OIL SENDER (STUD)
	19	BLUE	OIL LIGHT (SPARE)
YELLOW	#5		CAUTION FLASHER
	10	BLACK	FUEL GAUGE
	15	RED	HXY4 ADDED 6/95
	20	BLUE	HYD OIL LEVEL SENSOR TO BUZZER
	25	ORANGE	HYD OIL LEVEL SENSOR TO TEST SWITCH
BROWN	#6		BACK UP LIGHTS
	11	BLACK	CROSS-BULK SOL.
	16	RED	SEC-VIB - STAR ROLL - DEVINER SOL'S
	21	BLUE	PRIM-VIB SOL.
RIGHT SIDE OF CAB			
	31	FAN (RED)	#8 FUSE
	33	B-AC. COMPRESSOR SWITCH (ORANGE)	TO "B" ON RED FUSE
	30	B WIPER - RADIO (BLACK)	#9 FUSE
	20	DOME (PINK/BLU) (PURPLE)	#9 FUSE
	21M	DAK LIGHT (BROWN)	#9 FUSE
		FUEL GAUGE	

PRIM VIB ACT.

RED 26

LT. YELLOW. 27

SEC VIB ACT

BLUE 28

BROWN 29

FLASHERS

YELLOW. 30

PRIM LIGHTS

WHITE 31

SEC - CROSS - BL. LIGHTS.

BLACK 32

CAB

YELLOW. 33

No. 11 WIRE IN HANDLE TO #44 TO #10 FUSE. - BLACK 34

SPEEDOMETER

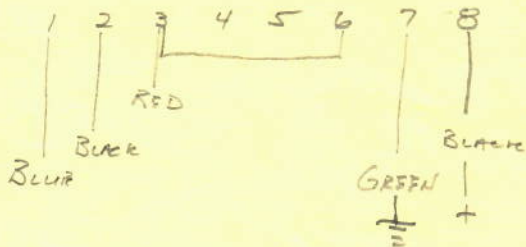

RED TO MAROON ON SENSOR 35

BLUE TO BLUE ON SENSOR 36

BLACK TO BLACK ON SENSOR 37

BLACK + 38

GREEN - 39

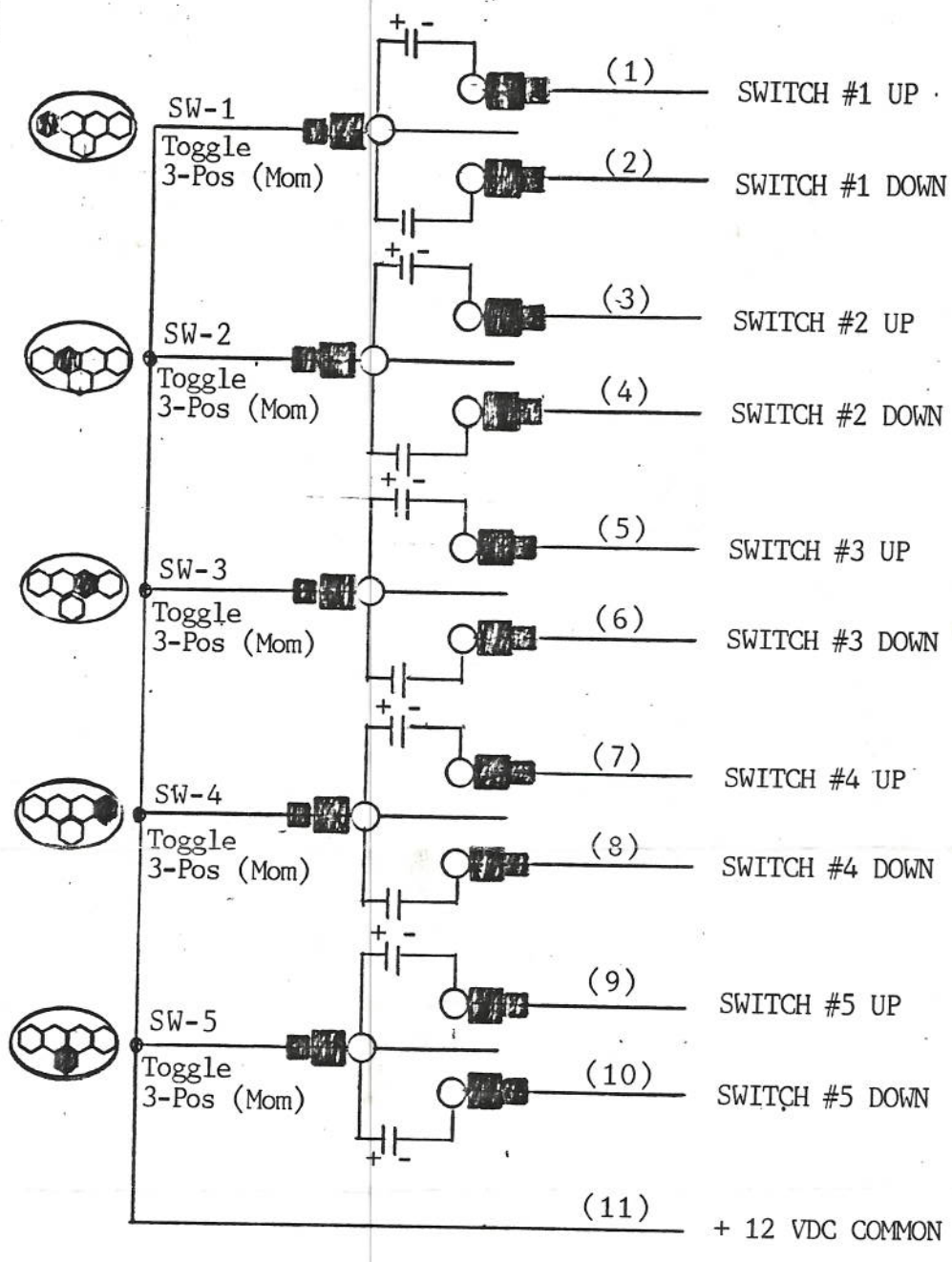

NOTES:
 1-Cyber-Tech, Inc. Proposed Handle wiring. Final wiring to be APPROVED by the Customer prior to INSTALLATION & OPERATOR USE.

REF: CONTROL HANDLE PART #88-A93141-01

Schematic Diagram

MODEL 8900 WITH FIVE (5) SPDT TOGGLE SWITCHES

SCALE: NONE

APPROVED BY:

DATE: 3-19-91

DRAWN BY GBD SR
 REVISED

LENCO MACHINE AND TOOL COMPANY

Cyber-Tech Inc.

P.O. Box 23801 Portland, Oregon 97223

DRAWING NUMBER
 SK-A93141-01